

# Accessories Guide

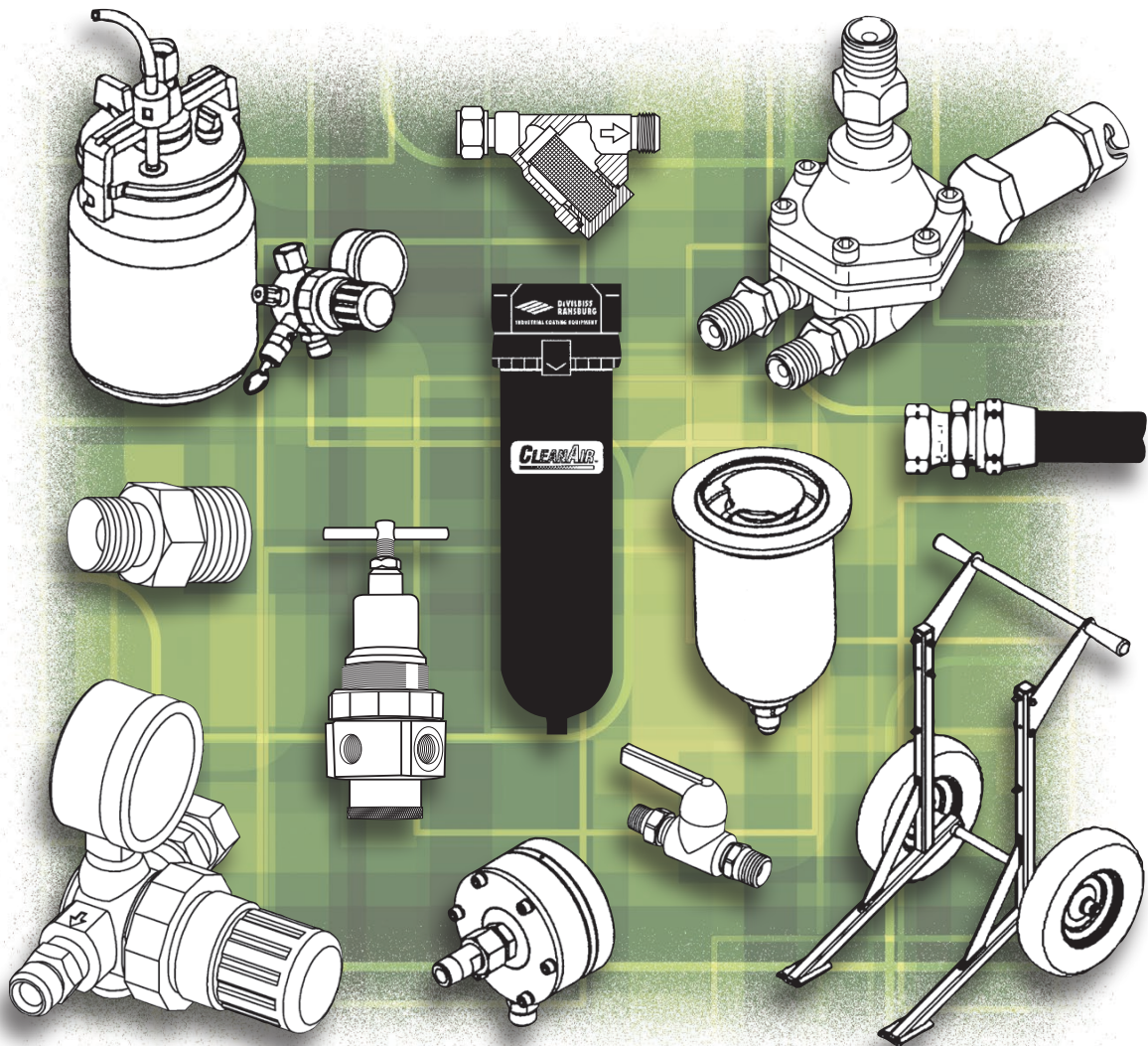

*Use genuine Binks and DeVilbiss Accessories,  
Repair Kits and Replacement Parts to keep your equipment  
at peak performance*

# Navigating this PDF

---

The Table of Contents has links to each section of this *Accessories Guide*. Click on any line in the Table of Contents to jump to that page.

To return to the Table of Contents, use the included bookmark in the **Bookmarks Panel**, which can be opened by clicking the **Bookmark icon** to the left of the main window (see illustration below), or through the menu interface: **View > Navigation Panels > Bookmarks**.

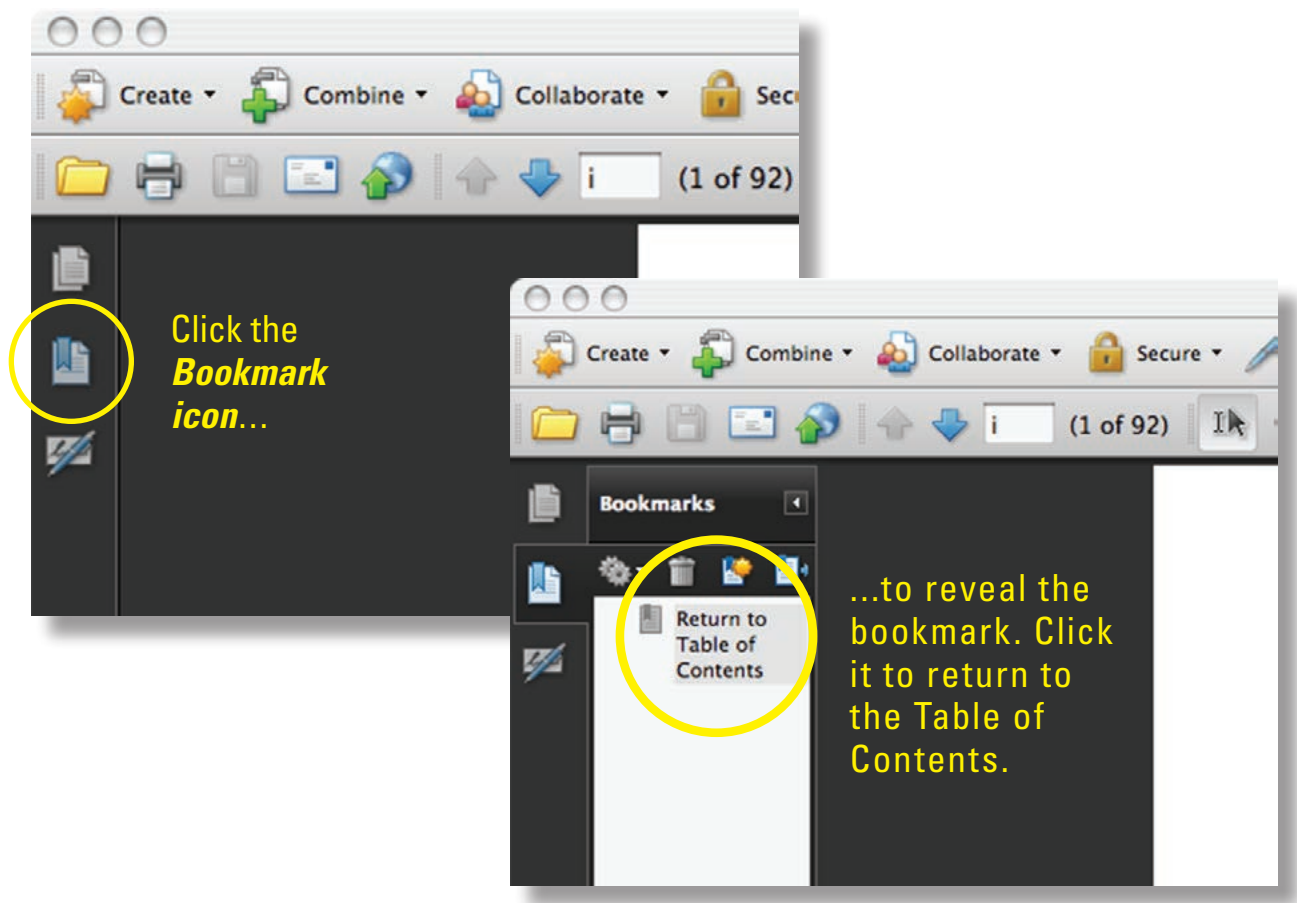

# Table of Contents

## 1. PUMP MOUNTING HARDWARE & ACCESSORIES

Pump Mounting Hardware	1-2
Pump Carts & Stands	1-3
Bung Adapters	1-3
Pail & Drum Covers	1-4
Drum Elevator	1-5
Ground Wire Kits	1-5
Air Line Lubricators	1-5
Pump Protectors / Air Runaway Valves	1-5
Air Motor Mufflers	1-6
Siphon Hoses / Sets (5 & 10 Gallon)	1-7
Siphon Hoses / Sets (55 Gallon)	1-8

## 2. FLUID FILTERS, SCREENS/STRAINERS, FILTER ELEMENTS & FILTER/SURGE CHAMBERS

Material Filters, Strainers, Screens	2-2
High Pressure In Line Filters	2-3
Low Pressure In Line Filters	2-3
Low Pressure In Line Y Strainers	2-4
Inlet Screens ( Rock Catchers)	2-4
Gun Mounted Mini Strainer	2-4
High Pressure Pump Filter Elements	2-5
High Pressure In Line Filter Elements	2-5
Low Pressure In Line Filter Elements	2-6
Surge Chambers / Pulsation Dampeners	2-6

## 3. FLUID REGULATORS, GAUGES & HEATERS

Fluid Regulators	3-4
Back Pressure Regulators	3-6
Gun Mount Non-Circulating Regulators	3-10
Gun Mount Circulating Regulators	3-10
Fluid Regulator Kits	3-12
Pressure Gauges & Riser Tubes	3-13
Fluid Heaters & FRP Heater Kits	3-14

## 4. AIR & FLUID VALVES

Ball Valves (Low Pressure)	4-2
Ball Valves (High Pressure)	4-2
Ball Valves (Air Vent)	4-3
VA Series Valves (Air & Fluid)	4-3
Air Adjustment Valves	4-4
Pressure Safety Relief Valves	4-4

## 5. HOSE, CONNECTIONS & ASSEMBLIES

Reusable Connections	5-2
Understanding Pressure Drop	5-3
Technical Data	5-4
Bulk Air Hose & Connections	5-5
Bulk Fluid Hose & Connections	5-8
Tubing & Connections	5-9
Air Hose Assemblies	5-12
Fluid Hose Assemblies	5-14
FRP Hose Assemblies	5-19
Catalyst Hose Assemblies (FRP)	5-21

## 6. FITTINGS

Adapters	6-2
Swivel Connections	6-2
Swivel Adapters	6-3
Swivel Unions	6-3
Reducing Bushings	6-4
Nipples & Reducing Nipples	6-4
Elbows	6-7
Misc. Connections	6-8
Tees & Crosses	6-8
Pipe Plugs	6-9
Quick Disconnects	6-10
Gun/Outlet Manifolds	6-12

## 7. AIR SUPPLY CONTROLS & GAUGES

Air Regulators	7-2
Bypass Air Regulators	7-4
Air Control Assemblies (Pumps)	7-6
Air Control Assemblies (Pressure Tanks)	7-7
Centrifugal Air Filters / Regulators	7-8
Coalescer Units	7-10
Desiccant Units	7-12
1 Stage Charcoal Filter	7-14
3 Stage Breathing Air Unit	7-14
2 Stage Filter / Regulator	7-14
Filter Element Kits	7-16
Air Vizor™ Breathable Air Systems	7-16
Air Pressure Gauges	7-17

## 8. CUPS & CUP ACCESSORIES

Siphon Cups	8-2
Pressure Cups	8-3
Gravity Feed Cups	8-4
Remote Pressure Cups	8-5
DeKups Disposable Cup System	8-6
Cup Accessories	8-8
Cup Gaskets	8-8

## 9. SPRAY GUN ACCESSORIES & MISC. PRODUCTS

Spray Gun Cleaning Kits, Brushes & Tools	9-2
Solvent Saver (Hose Gun Cleaner)	9-3
Spray Gun & Pump Lubricants / Fluids	9-3
Spray Gun Accessories	9-4
Air Regulators	9-5
Spray Gun Stands (Gravity Feed Guns)	9-6
Misc. Products	9-6



# Pump Mounting Hardware & Accessories

<b>PUMP MOUNTING HARDWARE</b>	<b>1-2</b>
<b>PUMP CARTS &amp; STANDS</b>	<b>1-3</b>
<b>BUNG ADAPTERS</b>	<b>1-3</b>
<b>PAIL &amp; DRUM COVERS</b>	<b>1-4</b>
<b>DRUM ELEVATOR</b>	<b>1-5</b>
<b>GROUND WIRE KITS</b>	<b>1-5</b>
<b>AIR LINE LUBRICATORS</b>	<b>1-5</b>
<b>PUMP PROTECTORS / AIR RUNAWAY VALVES</b>	<b>1-5</b>
<b>AIR MOTOR MUFFLERS</b>	<b>1-6</b>
<b>SIPHON HOSES / SETS (5 &amp; 10 GALLON)</b>	<b>1-7</b>
<b>SIPHON HOSES / SETS (55 GALLON)</b>	<b>1-8</b>

# Pump Mounting Hardware & Accessories

## Pump Wall Mounting Brackets

Part Number	Pump Style	Materials of Construction	Used with Air Motor	Notes
873184	Infinity	Painted black carbon steel	2", N Series and 4-1/4"	2" npt(f) threaded hole, open 55 gal. Rim mount
873115	Infinity	Painted black carbon steel	4-1/4", 6" 2 and 4 ball and 1" Gemini Diaphragm Pumps	Full hole cut-out
873134	Infinity	Painted black carbon steel	3:1 Gemini Diaphragm Pumps	4 bolt, full hole cut-out
873237	Infinity	Painted black carbon steel	8" Air Motors	4 bolt, full hole cut-out
873116	Infinity & Gemini 1/2"	Painted black carbon steel	N Series and 1/2" Gemini Diaphragm pumps	4 bolt, full hole cut-out
873189	Infinity	Painted black carbon steel	12" Air Motors	4 bolt, full hole cut-out
873461	Infinity	Painted black carbon steel	Raptor, Vector 8122XX and 8126XX series pumps	4 bolt, full hole cut-out, with air reg.mnt. holes
41-10705	Comet	Painted blue carbon steel	Comet 3 and 4" Air Motors	3 bolt, v cut. Holes for air reg. kit and bpr. or fltr.
207-12328	Exel	Unpainted zinc plated steel	Exel	4 hole for air mtr, 2 hole for mounting (2 Req'd)
0114-014806	Comet 4/12	Painted black carbon steel	Comet 4/12	4 bolt, full cut hole
DVP-50	DVP	Painted black carbon steel	Single DVP Diaphragm Pump	
41-28047	BX	Powder coated blue carbon steel	B8 and B10 Air Motors	Multiple mounting holes for air mtrs, regulators & heaters, etc
41-28091	BX	Powder coated blue carbon steel	B8 and B10 Air Motors	Multiple mounting holes for air motors, regulators & heaters, etc., air control
0115-010179	MX	Painted black carbon steel	MX-4/12 MX-4/32	Slotted bracket for wall or cart mount
41-718800	1/2" and 1" Gemini II Diaphragm Pumps	Powder coated black carbon steel	Gemini II	Slotted bracket
104095	MX - H.D.	Powder coated black carbon steel	MX3560, MX3070, MX35AA	Full cut hole

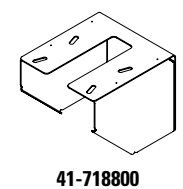
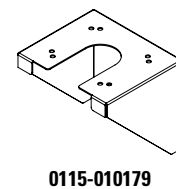
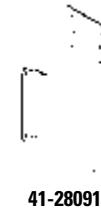
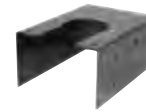
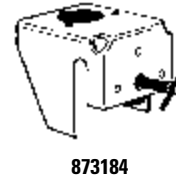

# Pump Mounting Hardware & Accessories

## Pump Carts & Stands

Part Number	Pump Style	Materials of Construction	Used with Air Motor	Notes	Service Form
873186	Infinity	Black painted carbon steel	4-1/4" and 6" 2 ball Infinity pumps	Large pneumatic tires	81224x and others
41-28050	BX	Blue painted carbon steel	BX-36 and BX-57 pumps	Large pneumatic tires	77-2902 77-2904
41-2208	Comet	Blue painted steel bracket with chrome plated, tubular steel cart	Comet 3" and 4" 18:1 and 30:1 pumps	Semi-pneumatic tires	77-2281
0110-011802	Comet 4/12	Aluminum	Comet 4/12 pumps	Tripod stand with plate	77-5463
0115-010100	MX 4/12 and MX 4/32	Aluminum	Binks MX 4/12 and MX 4/32	Tripod stand with plate	77-2912 77-2913
0115-010186	MX 4/12 and MX 4/32	Black painted carbon steel	Binks MX 4/12 and MX 4/32	Semi-pneumatic tires	77-2913
41-28280	MX Large Cart	Powder coated black carbon steel	MX3560, MX3070, MX35AA	Solid tires	



873186



41-28050



41-2208



0110-011802

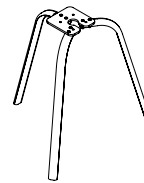

0115-010100

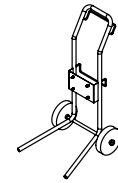

0115-010186

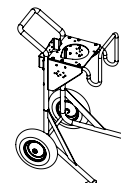

41-28280



873227

## Threaded Bung Adapter

Part Number	Materials of Construction	Notes
873227	Cast aluminum and steel	Threaded for 2" bung drum thread and used on Pogo series pumps. Includes thumb screw.

## Bunghole Adapter Kits

Part Number	Materials of Construction	Notes
41-15899	Stainless steel	With set screw and locknut. For 1/2" siphon tubes (7/8" o.d.).
41-15898	Stainless steel	With set screw and locknut. For 3/4" siphon tubes (1-1/8" o.d.).
41-15895	Stainless Steel	With set screw and locknut. For 1" siphon tubes (1-11/32" o.d.).



41-15895, 41-15898, 41-15899

# Pump Mounting Hardware & Accessories

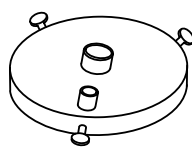

874502



41-3205



41-2455



41-718810



31-425

## 5 Gallon Pail Covers

Part Number	Pump Style	Materials of Construction	Used with	Notes	Service Form
874502	Infinity	Stainless steel	843000 Agitator	1/2" siphon tube. Siphon tube hole: .859" Agitator hole size: 1.745"	n/a
874503	Infinity, Gemini 1/2"	Stainless steel	1/2" Diaphragm pumps	Agitator hole in cover.	n/a
41-3205	Binks, Comet	Zinc chromate plated steel	Agitators / Pogo pumps	Agitator holes/knockouts, pump and siphon	77-1470
41-2455	Binks, Comet	Zinc chromate plated steel	Comet 18:1 and 30:1 pump outfits	Agitator hole and 2, 7/8" holes for regs or return	n/a
41-3230	Gemini DVP	Zinc chromate plated steel	Gemini DVP	Agitator hole	n/a
41-718810	Diaphragm	Stainless steel	Gemini II	With inspection port and agitator hole	n/a
31-425	Diaphragm	Stainless steel		Stainless steel with direct drive agitator	n/a

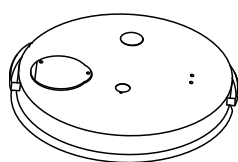

31-124

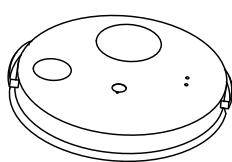

41-2414

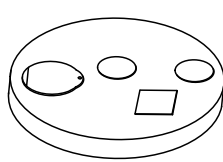

874506



41-718815



31-426

## 55 Gallon Drum Covers

Part Number	Pump Style	Materials of Construction	Used with	Notes	Service Form
874506	Infinity, Gemini 1/2"	Stainless steel	1/2" Diaphragm pumps and bung mntd. piston pumps such as 812490, pogo pumps	With insp. port, agitator hole and hole for pump or bung mount (55 Gal.) Hole sizes: 2.406" (medium hole), 1.75" (small hole), 4" (diameter), 4.875" x 6.125" (square hole), .875" (hole for pick-up tube).	n/a
31-124	Binks, Comet	Zinc chromate plated steel	55 Gal direct drive agitator	With insp. port, agitator hole and siphon tube hole	77-1481
41-2414	Binks, Comet	Zinc chromate plated steel	Comet 2.5:1 High-Vol	With agitator & inspection ports (55 Gal.)	n/a
41-718815	Diaphragm	Stainless steel	Gemini II	With insp. port, agitator hole and siphon tube hole	n/a
31-426	Diaphragm	Stainless steel			n/a



# Pump Mounting Hardware & Accessories

## Drum Elevator

Part Number	Lift Capacity	Notes	Shipping Weight	Service Form
41-9000	235 lbs @ 60 psi 395 lbs @ 100 psi	Comes with air control valve, 10 ft. of air tubing, mounting brackets and hardware. Floor mounting anchors and drum cover are not included. Use with 31-129 and 31-397 agitator assemblies. 35-1/8" lift height. 56-1/8" high with lid lowered. 91" high with lid raised.	68 lbs	77-1392



41-9000

## Ground Wire Kits

Part Number	Description	Notes
873067	Ground wire assy.	25 ft heavy duty sheathed wire with screw type clamp on one end and large ring terminal on the other.
41-13021	Ground wire assy.	8 ft long 18 gauge with small alligator clamp on one end and large ring terminal on the other.
0114-016243	Ground wire assy.	For use with Comet 4/12 pumps.



873067

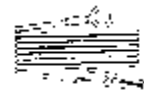

41-13021

## Air Line Lubricators

Part Number	Used on	Port Sizes	cfm Rating	Oil Capacity	Notes	Service Form
237-578	Binks	1/2" npt(f)	110 scfm	8oz/237ml	Zinc bowl Inc. sight glass. / 150 Deg. F / 250 psi	n/a



237-578

## Pump Protectors / Air Runaway Valves

Part Number	Pumps used on	cfm Range	Pressure Range	Service Form
41-11150	Binks B series / Infinity	10-150 cfm	20-125 psi	77-2257

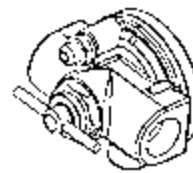

41-11150

# Pump Mounting Hardware & Accessories

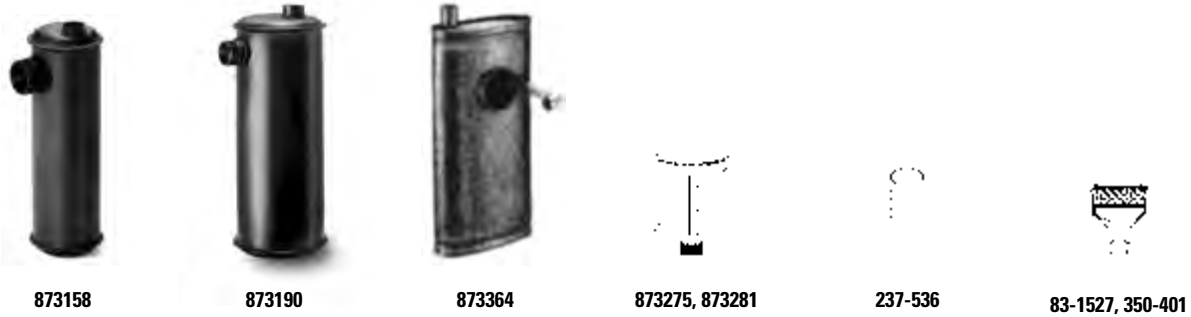

## Air Motor Mufflers

Part Number	Pump Style	Air Inlet Size	Dimensions	Notes
873158	Infinity 4-1/4" and 6" air motors	1-1/4" male, npt	3-1/2" x 11-3/16"	Used with 4-1/4" and 6" air motor pumps
873190	Infinity 8" air motors	1-1/4" male, npt	5-5/8 x 15-3/8"	Used with 8" air motor pumps
873364	Infinity 12" air motor	Bolted On	9" x 20"	Used with Infinity 12" air motors
873275	Gemini	3/8" male, npt	2-15/16" long x 1" o.d.	Metal, 1/2" thread depth
873281	Gemini	3/4" male, npt	4-1/2" long x 2-3/4" o.d.	Black plastic, 7/8" thread depth
237-536	Exel / Unison Pumps	1/2" male, npt	3-1/8" x 1-1/4"	Aluminum, 50M stn stl screen
83-1527	Air Motor Agitators	1/4" male, npt	1-5/8" x 1-3/4"	Steel body, felt muffler
350-401	Air Motor Agitators	1/4" male, npt	1-5/8" x 1-3/4"	Steel body, felt muffler
192509	MX Heavy Duty Pump	1-1/2" BSPT(m)	13-1/2" x 5-1/4"	Used on MX35AA, MX3560 and MX3070

# Pump Mounting Hardware & Accessories

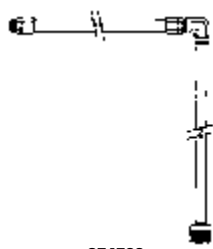

874500



874504

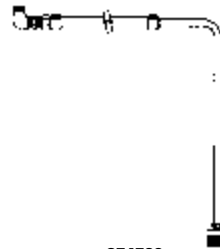

874509

41-17237, 41-17238

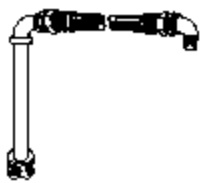

44-350, 103-1093



41-718818-5, 41-718819-5



41-2294, 41-2296

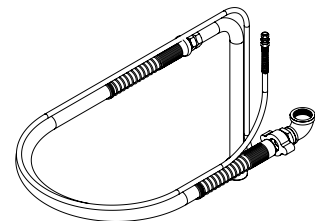

41-28270-5

## Siphon Hoses / Sets (5 & 10 Gallon)

Part Number	Pumps Used with	Hose Size i.d.	Tube Size	Fitting Size	Siphon Hose Length	Included Screen (Mesh)	Container Size	Wetted Parts	Service Form
874500	Infinity	1"	3/4" x 16"	3/4" male, npt	5'	30	5 Gallon	Stainless steel	n/a
874504	Infinity	1/2"	1/2" x 16"	1/2" male, npt	5'	30	5 Gallon	Stainless steel	n/a
874509	Infinity / Raptor	1/2"	1/4" x 19"	1/2" male, npt	5'	30	5 Gallon	Stainless steel	n/a
41-17237	Comet 4/12	3/8"	3/8" x 13-5/8"	m25 x 1" (m)	3'	50	5 Gallon	Stainless steel	77-5461, 77-5462, 77-5463
41-17238	Binks MX-4/12 & MX-4/32	3/8"	3/8" x 13-5/8"	1/2" female, nps	3'	50	5 Gallon	Stainless steel	77-2912, 77-2913
41-17260	MX4-12	3/8" i.d.	3/8" x 13-5/8"	3/4" nps(f)	3'	50	5 Gallon	Stainless steel	
41-17262	Binks	3/4"	17 mm i.d. x 640 mm long		5'	30	5 Gallon	Stainless steel	
0115-010236	MX1212, MX1231						5 Gallon		
103-1093	Binks / Comet	1"	1" x 16"	1" male, npt	5'	8/16	5 Gallon	Aluminum, steel	77-2126
44-350	Binks / Comet	3/4"	3/4" x 17"	3/4" male, npt	5'	8	5 Gallon	Stainless steel	77-2098
41-718818-5	Gemini II	1/2"	1/2" x 12"	1/2" npt	5'	30	5 Gallon	Polypropylene	77-3039
41-718819-5	Gemini II	1/2"	1/2" x 12"	1/2" npt	5'	30	5 Gallon	Stainless steel	77-3035
41-2294	Binks / Comet	3/4"	3/4" x 16"	3/4" male, npt	5'	30	5 & 10 Gallon	Aluminum, steel	77-2098
41-2296	Binks / Comet	1"	1" x 16"	1" male, npt	5'	30	5 & 10 Gallon	Aluminum, steel	77-2098
41-28270-5	MX35AA, MX3070, MX3560	1"	1" bent tube	1-1/2" npt(f)	5'	8/16	5 Gallon	Aluminum	

SEE PAGE 2-4 FOR REPLACEMENT INLET SCREENS

# Pump Mounting Hardware & Accessories

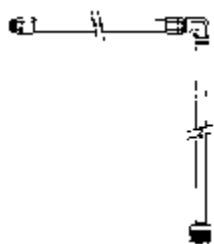

874501



874580



41-17233

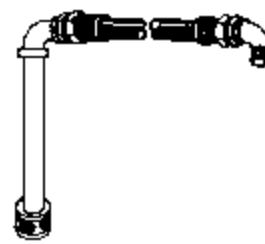

41-2616, 41-10467

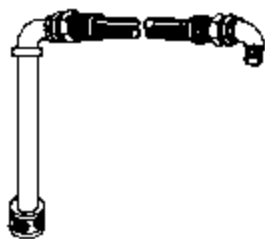

44-155, 44-355



0115-010381

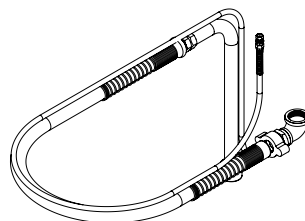

41-28270-55



41-718818-55, 41-718819-55

## Siphon Hoses / Sets (55 Gallon)

Part Number	Pumps Used with	Hose Size i.d.	Tube Size	Fitting Size	Siphon Hose Length	Included Screen (Mesh)	Container Size	Wetted Parts	Service Form
874501	Infinity	1"	3/4" i.d. x 36"	3/4" male, npt	5 ft.	30	55 Gallon	Stainless steel	n/a
874580	Infinity / Raptor	1/2"	1/2" i.d. x 35.5"	1/2" male, npt	5 ft.	30	55 Gallon	Stainless steel	77-5322
41-17233*	Comet 4/12 / Binks MX-4/12 & MX-4/32	3/4"	3/4" i.d. x 36"	3/4" female, nps	8 ft.	50	55 Gallon	Stainless steel	77-5461, 77-2912
44-355	Binks / Comet	1"	3/4" i.d. x 35"	1" male, npt	8 ft.		55 Gallon	Stainless steel	77-2098
41-2616	Binks / Comet	3/4"	3/4" i.d. x 33"	3/4" male, npt	8 ft.	16	55 Gallon	Aluminum, steel	77-2098
41-10467	Binks / Comet	1"	1" i.d. x 35"	1" male, npt	8 ft.	30	55 Gallon	Galvanized steel	77-2098
0115-010381	Binks MX-12/12	3/4"	21/32" i.d. x 36"	3/4" female, nps	10 ft.		55 Gallon	Stainless steel	77-2917
41-28270-55	MX35AA, MX3070, MX3560	1"	1" bent tube	1" npt(m)	8 ft.	8/16	55 Gallon	Aluminum	
41-718818-55	Gemini II	1/2"	1/2" x 33"	1/2" npt	10 ft.	30	55 Gallon	Polypropylene	77-3035
41-718819-55	Gemini II	1/2"	1/2" x 33"	1/2" npt	10 ft.	30	55 Gallon	Stainless steel	77-3035

\*Requires adapter 0114-013801 for Comet 4/12.

\*Requires adapter 0115-010235 for MX-4/12 and MX-4/32.

SEE PAGE 2-4 FOR REPLACEMENT INLET SCREENS

# Fluid Filters, Screens/Strainers, Filter Elements & Filter/Surge Chambers

<b>MATERIAL FILTERS, STRAINERS, SCREENS</b>	<b>2-2</b>
<b>HIGH PRESSURE IN LINE FILTERS</b>	<b>2-3</b>
<b>LOW PRESSURE IN LINE FILTERS</b>	<b>2-3</b>
<b>LOW PRESSURE IN LINE Y STRAINERS</b>	<b>2-4</b>
<b>INLET SCREENS (ROCK CATCHERS)</b>	<b>2-4</b>
<b>GUN MOUNTED MINI STRAINER</b>	<b>2-4</b>
<b>HIGH PRESSURE PUMP FILTER ELEMENTS</b>	<b>2-5</b>
<b>HIGH PRESSURE IN LINE FILTER ELEMENTS</b>	<b>2-5</b>
<b>LOW PRESSURE IN LINE FILTER ELEMENTS</b>	<b>2-6</b>
<b>SURGE CHAMBERS / PULSATION DAMPENERS</b>	<b>2-6</b>

# Fluid Filters, Screens/Strainers, Filter Elements & Filter/Surge Chambers

2

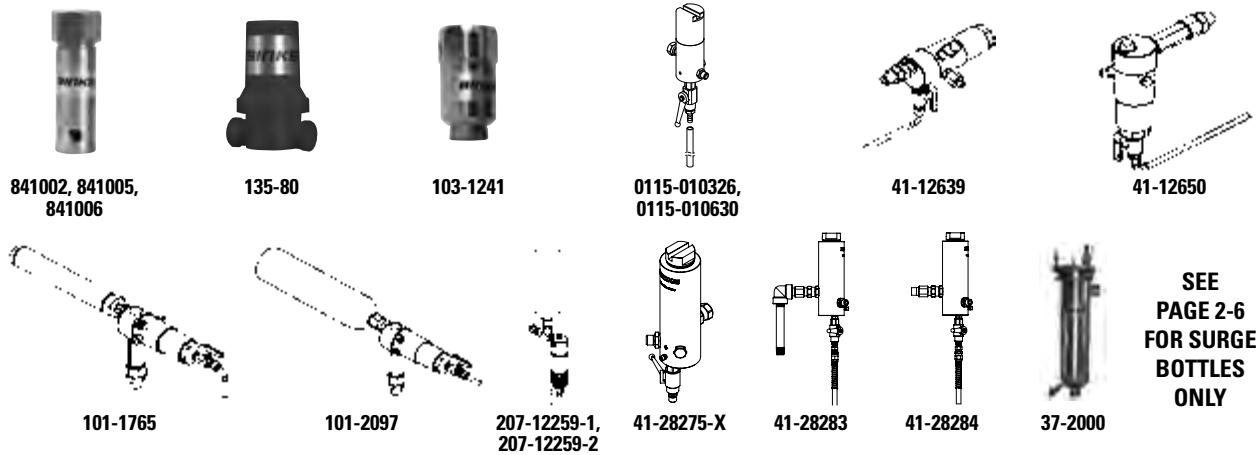

## Material Filters, Strainers, Screens

Part Number	Description	Inlet Port	Used with	Outlet Port	Mesh	Micron	Materials of Construction	Maximum Working Pressure	Service Form
841002	Material Filter	(2) 1/2" npt(f)	Infinity	(2) 1/2" npt(f)	100	149	Carbon steel	6000 psi	84100X
841005	Material Filter	(2) 1/2" npt(f)	Infinity	(2) 1/2" npt(f)	70	210	Stainless steel	6000 psi	84100X
841006	Material Filter	(2) 1/2" npt(f)	Infinity	(2) 1/2" npt(f)	100	149	Stainless steel	6000 psi	84100X
873188	Outlet adapter to mount 841006 filter	1" npt(m)	Infinity	1/2" npt(m)			Stainless steel	6000 psi	
135-80	Material Filter	3/8" npt(f)	Infinity Diaph	3/8" npt(f)	40	420	Polypropylene	150 psi	84101X
103-1241*	Material Filter	3/8" nps(f)	Binks / Comet	1/4" npt(f)	100	149	Stainless steel	4000 psi	77-2015
0110-009130	Material Filter	3/8" bsp	MX	1/4" nps	100	149	Stainless steel	7200 psi	77-2890
37-2000	Material Filter	1" Sant.	Maple/Smart	1" Sant.			Stainless steel		ASI-4000.2
0115-010326	Material Filter	3/8" bspp(f)	Binks MX-4/12 & MX-4/32 / Comet 4/12	1/4" nps(m)	100	149	Stainless steel	7200 psi	77-2912
0115-010630	Material Filter	3/8" bspp(f)	Binks MX-4/12 & MX-4/32 / Comet 4/12	1/4" nps(m)	200	149	Stainless steel	7200 psi	77-2913
41-12639	Material Filter	1/2" npt(m)	Binks / Comet	1/4" nps(m)	50	297	Carbon steel	6000 psi	77-2164
41-12650	Material Filter	1/2" npt(m)	Binks / Comet	1/4" nps(m)	50	297	Carbon steel	6000 psi	77-2164
101-1765	Material Filter/ Pulsation Chamber	1/2" npt(m)	Binks / Comet	1/4" nps(m)	50	297	Carbon steel	6000 psi	77-2469
101-2097	Material Filter/ Pulsation Chamber	1/2" npt(m)	Binks / Comet	1/4" nps(m)	50	297	Carbon steel	6000 psi	77-2469
207-12259-1	Material Filter/ Pulsation Chamber	1/2" npt(f)	Binks / Comet	1/2" npt(f)	60	250	Carbon steel/ aluminum	1800 psi	77-2807
207-12259-2	Material Filter/ Pulsation Chamber	1/2" npt(f)	Binks / Comet	1/2" npt(f)	100	149	Carbon steel/ aluminum	1800 psi	77-2807
41-28275-30	Material Filter	3/8" nps(m)	MX3560	1/4" nps(m)	30	575	303 s.s.	7250 psi	
41-28275-50	Material Filter	3/8" nps(m)	MX3560	1/4" nps(m)	50	297	303 s.s.	7250 psi	
41-28275-70	Material Filter	3/8" nps(m)	MX3560	1/4" nps(m)	70	210	303 s.s.	7250 psi	
41-28275-100	Material Filter	3/8" nps(m)	MX3560	1/4" nps(m)	100	149	303 s.s.	7250 psi	
193330	Material Filter	M22-1.5 mm	MX3560	Hose barb	100	149	Stainless steel	7250 psi	
41-28283-30	Material filter top mount	1/2" npt(m)	Maple 7/15, 8/25	1/4" nps(m)	30	575	303 s.s.	7250 psi	
41-28283-50	Material filter top mount	1/2" npt(m)	Maple 7/15, 8/25	1/4" nps(m)	50	297	303 s.s.	7250 psi	
41-28283-70	Material filter top mount	1/2" npt(m)	Maple 7/15, 8/25	1/4" nps(m)	70	210	303 s.s.	7250 psi	
41-28283-100	Material filter top mount	1/2" npt(m)	Maple 7/15, 8/25	1/4" nps(m)	100	149	303 s.s.	7250 psi	
41-28284-30	Material filter top mount	1/2" npt(m)	Maple 7/15, 8/25	1/4" nps(m)	30	575	303 s.s.	7250 psi	
41-28284-50	Material filter top mount	1/2" npt(m)	Maple 7/15, 8/25	1/4" nps(m)	50	297	303 s.s.	7250 psi	
41-28284-70	Material filter top mount	1/2" npt(m)	Maple 7/15, 8/25	1/4" nps(m)	70	210	303 s.s.	7250 psi	
41-28284-100	Material filter top mount	1/2" npt(m)	Maple 7/15, 8/25	1/4" nps(m)	100	149	303 s.s.	7250 psi	

\*Includes 1 ea, 101-9120 1/4" npt(m) x 1/4" npt(m) swivel adapter.

**SEE PAGE 2-5 FOR REPLACEMENT SCREENS**

# Fluid Filters, Screens/Strainers, Filter Elements & Filter/Surge Chambers

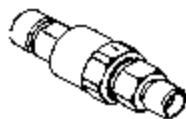

54-4725



54-3655

## High Pressure In Line Filters

Part Number	Description	Inlet Port	Used with	Outlet Port	Mesh	Micron	Materials of Construction	Maximum Working Pressure	Service Form
54-4725	In-Line Edge Filter Assy	1/4" nps(m)	Binks	7/16-20 unf 2a thread	100	149	Stainless steel	4000 psi	77-2838
54-3655	In-Line Edge Filter Assy	1/4" nps(m)	Binks	1/4" nps(f)	100	149	Stainless steel	5800 psi	n/a
72-2341	In-Line Edge Filter Assy	1/4" nps(m)	Binks	1/4" nps(f)	100	149	Stainless steel	7500 psi	n/a
72-2340	In-Line Edge Filter Assy	1/4" nps(m)	Binks	1/4" nps(f)	60	250	Stainless steel	7500 psi	n/a

SEE PAGE 2-5 FOR REPLACEMENT ELEMENTS



54-990, 54-981



VS-534



VS-531

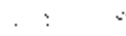

VS-532

## Low Pressure In Line Filters

Part Number	Description	Inlet Port	Used with	Outlet Port	Mesh	Micron	Materials of Construction	Maximum Working Pressure	Service Form
54-990	In line Cartridge Filter	3/8" nps(m)	Binks	3/8" nps(f)	100	149	Plated brass	150 psi	n/a
54-981	In line Cartridge Filter	3/8" nps(m)	Binks	3/8" nps(f)	150	100	Plated brass	150 psi	n/a
VS-534	In line Cartridge Filter	3/8" nps(m)	Devilbiss	3/8" nps(f)	100	149	Stainless steel	300 psi	SB-7-072
VS-531	In line Cartridge Filter	3/8" nps(m)	Devilbiss	3/8" nps(f)	100	149	Carbon steel	300 psi	SB-7-072
VS-532	In line Cartridge Filter	3/8" nps(m)	Devilbiss and Binks	3/8" nps(f)	100	149	Plated brass	300 psi	SB-7-072

SEE PAGE 2-5 FOR REPLACEMENT ELEMENTS

# Fluid Filters, Screens/Strainers, Filter Elements & Filter/Surge Chambers

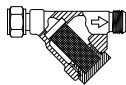

## Low Pressure In Line Y-Strainers

Part Number	Description	Inlet Port	Used with	Outlet Port	Mesh	Micron	Materials of Construction	Maximum Working Pressure	Service Form
83-2922	In Line Filter	3/8" nps(f)	Binks	3/8" nps(m)	50	297	Plated brass / Stainless steel	200 psi	77-2394
83-2923	In Line Filter	3/8" nps(f)	Binks	3/8" nps(m)	80	177	Plated brass / Stainless steel	200 psi	77-2394
83-2924	In Line Filter	3/8" nps(f)	Binks	3/8" nps(m)	100	149	Plated brass / Stainless steel	200 psi	77-2394
83-2925	In Line Filter	3/8" nps(f)	Binks	3/8" nps(m)	150	96	Plated brass / Stainless steel	200 psi	77-2394
83-2926	In Line Filter	3/8" nps(f)	Binks	3/8" nps(m)	200	74	Plated brass / Stainless steel	200 psi	77-2394

SEE PAGE 2-5 FOR REPLACEMENT ELEMENTS



101-142, 41-10094,  
41-2661, 41-2662, 41-2663



41-17234-K10



41-2288

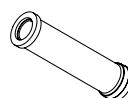

41-17241

## Inlet Screens (Rock Catchers)

Part Number	Thread Size	Materials of Construction	Mesh Size	Pumps used with
101-142	1" npt(f)	Stainless steel	8/16	Comets B,C,D
41-10094	3/4" npt(f)	Stainless steel	16	Comets B,C,D
41-2661	1/2" npt(f)	Stainless steel	30	Comets B,C,D / Raptor / MX-12/12 / Gemini II
41-2662	3/4" npt(f)	Stainless steel	30	Comets B,C,D
41-2663	1" npt(f)	Stainless steel	30	Comets B,C,D
41-2288	1- 5/8" -12 npt(f)	Stainless steel	50 (4" dia.)	Comets 3B and 4B Foot Valve
41-17234-K10	Ribbed hole 3/8" o.d. tubing	Rubber / stainless steel	50	Comet 4/12
41-17241-K2	m12 x 1.25-6H screen	Stainless steel / Glass filled PTFE	50	Binks MX-4/12 and MX-4/32
237-755	3/16" or 1/4" i.d. tubing	Polypropylene	75 micron	Unison Catalyst Supply Bottle

SEE PAGES 1-7 AND 1-8 FOR SIPHON SUPPLY SETS

## Gun Mounted Mini Strainer

Part Number	Description	Inlet Port	Used with	Outlet Port	Mesh	Micron	Materials of Construction	Maximum Working Pressure
PLH-MF-6-100	Gun Mounted	3/8" nps(m)	Devilbiss / Binks	3/8" nps(f)	100	149	Stainless steel	250 psi



SEE PAGE 2-5 FOR REPLACEMENT ELEMENTS



# Fluid Filters, Screens/Strainers, Filter Elements & Filter/Surge Chambers



873146, 873147



83-1256, 83-2089



0110-009132



41-2627, 41-2628, 41-2629,  
41-2630, 107-1527



207-11693, 207-11694

## High Pressure Pump Filter Elements

Filter Assembly	Filter Element Standard	Mesh	Filter Element Optional	Mesh
841001 (OBS)	873146	70	873147	100
841002	873147	100	873146	70
841005	873146	70	873147	100
841006	873147	100	873146	70
103-1241	83-1256	100	83-2089	50
0110-009130 (OBS)	0110-009132	100	0110-009131	50
			0110-009133	150
			0110-009060	200
0115-010326	0110-009132	100	0110-009131	50
			0110-009133	150
			0110-009134	200
0115-010630			0110-009134	200
			0110-009132	100
			0110-009133	150
41-12650 & 41-12639	41-2629	50	41-2627 107-1527	100 20
207-12259-1	207-11693	60	207-11694	100
207-12259-2	207-11694	100	207-11693	60
101-1765 & 101-2097	41-2629	50	41-2627 107-1527	100 20
193330 (obs)	0114-014883	100	0114-014884	70
41-28275	0114-014883	100	0114-014884	70

**FOR USE WITH FILTER ASSEMBLIES ON PAGE 2-2**



54-1835, 54-1836

## High Pressure In Line Filter Elements

Filter Assembly	Filter Element Standard	Mesh	Filter Element Optional	Mesh
54-4725	54-1835	100	54-1836	60
54-3655	54-1835	100	54-1836	60
72-2341	54-1835	100		
72-2340	54-1836	60		

**FOR USE WITH FILTERS ON PAGE 2-3**



54-5788-K5, 54-5789-K5

## High Pressure In Line Filter Elements

Filter	Size (Mesh)	Where Used
54-5788-K5	60	AA-1600M, AA-4400M
54-5789-K5	100	AA-1600M, AA-4400M

# Fluid Filters, Screens/Strainers, Filter Elements & Filter/Surge Chambers

## Low Pressure In Line Filter Elements

Filter Assembly	Filter Element Standard	Mesh	Filter Element Optional	Mesh
841010	135-78	40 x 36	135-77	80 x 80
83-29XX series			83-2705	30
83-2922	83-2089	50		
83-2923	83-2596	80		
83-2924	83-1256	100		
83-2925	83-2405	150		
83-2926	83-2706	200		
54-990	54-987	100		
54-981	54-980	150		
54-988	54-987	100		
54-982	54-980	150		
VS-532	VS-58-K10	100		
VS-534	VS-58-K10	100		
VS-531	31144-310-K10	100		
PLH-MF-6-100	PLH-MFC-100	100		

FOR USE WITH FILTERS ON PAGES 2-3 AND 2-4



844000



873067



41-1020



237-847

## Surge Chambers / Pulsation Dampeners

Part Number	Pressure Range	Fitting Sizes	Wetted Parts	Notes	Service Form
844000	0-100 psi	1" npt(f) fittings	Conductive acetal and PTFE	Reduces pulsation by up to 97%. Helps reduce foaming and hydraulic shock. 873067 Grounding Kit.	844000
873067	n/a	n/a	n/a	Grounding Kit for 844000	840000
41-1020	0-4000 psi	3/8" npt(f)	Plated steel, painted blue exterior	Surge bottle only	77-2469
237-847	0-1800 psi	3/4-16-unf-2b	Aluminum	Surge bottle only	77-2807



135-77, 135-78



54-980, 54-987



VS-58-K10



83-2405, 83-2596, 83-2705, 83-2706



31144-310-K10



PLH-MFC-100



102-2181



104 Series

## 104 Series Surge Chambers



104050P-B-B	2" Sanitary Active Surge Eliminator
104050P-C-C	1-1/2" Sanitary Active Surge Eliminator
104050P-D-D	1-1/2" npt(f) Active Surge Eliminator
104050P-L-L	1" Sanitary Active Surge Eliminator
104053-C-C	1-1/2" Sanitary Surge Chamber
104053-D-D	1-1/2" npt(f) Surge Chamber
104053-L-L	1" Sanitary Surge Chamber

# Fluid Regulators, Gauges & Heaters

<b>FLUID REGULATORS</b>	<b>3-2</b>
<b>BACK PRESSURE FLUID REGULATORS</b>	<b>3-6</b>
<b>GUN MOUNT NON-CIRCULATING REGULATORS</b>	<b>3-10</b>
<b>GUN MOUNT CIRCULATING REGULATORS</b>	<b>3-10</b>
<b>FLUID REGULATOR KITS</b>	<b>3-12</b>
<b>PRESSURE GAUGES &amp; RISER TUBES</b>	<b>3-13</b>
<b>FLUID HEATERS &amp; FRP HEATER KITS</b>	<b>3-14</b>

# Fluid Regulators, Gauges & Heaters

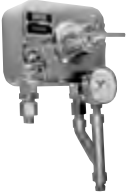
## Low Pressure Fluid Regulators

	Part Number	Wetted Parts	Inlet	Outlet	Inlet Pressure Min.	Inlet Pressure Max.	Outlet Pressure Min.	Outlet Pressure Max.
	For Ceramic Glaze							
	84-120	Nickel Plated Brass	3/8"npt(m)	3/8"nps(m)	n/a	100 psi / 7 bar	5 psi / .35 bar	40 psi / 2.7 bar
	HGB-502-1	Stainless steel	3/8"npt(f)	(2) 3/8"npt(f)	50 psi / 3.5 bar	175 psi / 12 bar	10 psi / .7 bar	75 psi / 5 bar
	HGB-508-1	Stainless steel	3/8"nps(f)	3/8"nps(m) / 3/8"npt(f)	50 psi / 3.5 bar	175 psi / 12 bar	10 psi / .7 bar	75 psi / 5 bar
	HGB-509-5-R38	Stainless steel	3/8bsp(f)	3/8"nps / bsp(m)	30 psi / 2 bar	180 psi / 12.5 bar		75 psi / 5 bar
	HGB-609-1.2-R38	Stainless steel	3/8"bsp(f)	3/8"nps / bsp(m)	15 psi / 1 bar	115 psi / 8 bar		35 psi / 2.5 bar
	HGB-609-5-R38	Stainless steel	3/8"bsp(f)	3/8"nps / bsp(m)	30 psi / 2 bar	175 psi / 12 bar		75 psi / 5 bar
	HGB-609-9-R38	Stainless steel	3/8"bsp(f)	3/8"nps / bsp(m)	45 psi / 3 bar	215 psi / 15 bar		130 psi / 9 bar
	84-410	Stainless steel	3/8"npt(f)	3/8"nps(m) / 3/8"npt(f)		100 psi / 7 bar	1 psi / .1 bar	12 psi / 1 bar
	84-320	Stainless steel	3/8"npt(m)	3/8"nps(m)		200 psi / 14 bar	5 psi / .3 bar	55 psi / 4 bar
	84-407	Stainless steel	3/8"npt(f)	3/8"nps(m) / 1/4" npt (f)		200 psi / 14 bar	5 psi / .3 bar	55 psi / 4 bar
	84-409	Stainless steel	3/8"npt(m)	3/8"nps(m) / 3/8"npt(f)		200 psi / 14 bar	5 psi / .3 bar	100 psi / 7 bar
	84-346	Zinc plated	3/8"npt(m)	3/8"nps(m) / 1/4"npt(f)		100 psi / 7 bar	1 psi / .1 bar	12 psi / 1 bar
	84-345	Zinc plated	3/8"npt(m)	3/8"nps(m)		200 psi / 14 bar	5 psi / .3 bar	55 psi / 4 bar
	84-411	Zinc plated	3/8"npt(m)	3/8"nps(m)		200 psi / 14 bar	5 psi / .3 bar	100 psi / 7 bar
	84-412	Zinc plated	3/8"npt(m)	3/8"nps(m)		200 psi / 14 bar	5 psi / .3 bar	100 psi / 7 bar

# Fluid Regulators, Gauges & Heaters



## Low Pressure Fluid Regulators

Part Number	Capacity	Type	Gauge	Shipping Weight	Service Forms
<b>For Ceramic Glaze</b>					
<b>84-120</b>	1 gpm / 3.8 lpm	Key	83-1355 gauge 100 / 0-7 bar		77-1417
<b>HGB-502-1</b>	8 gpm / 30 lpm	Key (adaptable to remote)	None		SB-6-375
<b>HGB-508-1</b>	8 gpm / 30 lpm	Key (adaptable to remote)	HGB-14 riser tube & 83-2727 gauge 100 psi / 6.5 bar		SB-6-375
<b>HGB-509-5-R38</b>	3.4 gpm / 13 lpm	Key	None		SB-6-HGB-H
<b>HGB-609-1.2-R38</b>	2.2 gpm / 8.3 lpm	Key	MA-25 gauge 35 psi / 2.5 bar		SB-6-HGB-H
<b>HGB-609-5-R38</b>	3.4 gpm / 13 lpm	Key	83-2727 gauge 100 psi / 7 bar		SB-6-HGB-H
<b>HGB-609-9-R38</b>	3.4 gpm / 13 lpm	Key	GA-288 gauge 160 psi / 11 bar		SB-6-HGB-H
<b>84-410</b>	12 oz/Min. / .4 lpm	Key (adaptable to remote)	84-348 riser tube & 83-1414 gauge 30 psi / 2 bar		77-1921
<b>84-320</b>	1 gpm / 3.8 lpm	Key (adaptable to remote)	84-348 riser tube & 83-2571 gauge 100 psi / 6.5 bar		77-1486
<b>84-407</b>	1 gpm / 3.8 lpm	Remote operated	84-348 riser tube & 83-2571 gauge 100 psi / 6.5 bar		77-1486
<b>84-409</b>	1 gpm / 3.8 lpm	Key (adaptable to remote)	84-348 riser tube & 83-2571 gauge 100 psi / 6.5 bar		77-1915
<b>84-346</b>	12 oz/Min. / .4 lpm	Key (adaptable to remote)	84-40 riser tube & 83-1636 gauge 15 psi / 1 bar		77-1758
<b>84-345</b>	1 gpm / 3.8 lpm	Key (adaptable to remote)	84-40 riser tube & 83-1355 gauge 100 psi / 6.5 bar		77-1632
<b>84-411</b>	1 gpm / 3.8 lpm*	Key (adaptable to remote)	84-40 riser tube & 83-1355 gauge 100 psi / 6.5 bar		77-2011
<b>84-412</b>	1 gpm / 3.8 lpm	Key (adaptable to remote)	84-40 riser tube & 83-1290 gauge 150 psi / 10 bar		77-1632

\* For high viscosity materials 2 gpm / 7.6 lpm for low viscosity

# Fluid Regulators, Gauges & Heaters

## Low Pressure Fluid Regulators

Part Number	Wetted Parts	Inlet	Outlet	Inlet Pressure Min.	Inlet Pressure Max.	Outlet Pressure Min.	Outlet Pressure Max.
<b>Air pilot</b>							
 <b>HGB-510-R1</b>	Stainless steel	1/4"bsp(f)	1/4"bsp(f)	30 psi / 2 bar	220 psi / 15 bar		220 psi / 15 bar
<b>HGB-510-R2</b>	Stainless steel	1/4"bsp(f)	1/4"bsp(f)	15 psi / 1 bar	220 psi / 15 bar		100 psi / 7 bar
<b>HGB-510-R4</b>	Stainless steel	1/4"bsp(f)	1/4"bsp(f)	15 psi / 1 bar	220 psi / 15 bar		60 psi / 4 bar
<b>HGB-510-R1-CO</b>	Stainless steel	3/8"nps/bsp(m)	1/4"bsp(f)	30 psi / 2 bar	220 psi / 15 bar		220 psi / 15 bar
<b>HGB-510-R2-CO</b>	Stainless steel	3/8"nps/bsp(m)	1/4"bsp(f)	15 psi / 1 bar	220 psi / 15 bar		100 psi / 7 bar
<b>HGB-510-R4-CO</b>	Stainless steel	3/8"nps/bsp(m)	1/4"bsp(f)	15 psi / 1 bar	220 psi / 15 bar		60 psi / 4 bar
 <b>845020</b>	Stainless steel / Tungsten carbide	1/4"npt(f)	(2) 1/4"npt(f)		750 psi / 52 bar	0 psi / 0 bar	30 psi / 2 bar
 <b>845004</b>	Stainless steel / Tungsten carbide	3/8"npt(f)	3/8"npt(f)		750 psi / 52 bar	20 psi / 1.4 bar	60 psi / 4 bar

## Medium Pressure Fluid Regulators

Part Number	Wetted Parts	Inlet	Outlet	Inlet Pressure Min.	Inlet Pressure Max.	Outlet Pressure Min.	Outlet Pressure Max.
 <b>845001</b>	Stainless steel / Tungsten carbide	3/8"npt(f)	3/8"npt(f)		1250 psi / 86 bar	100 psi / 7 bar	800 psi / 55 bar

# Fluid Regulators, Gauges & Heaters

## Low Pressure Fluid Regulators



Part Number	Capacity	Type	Gauge	Shipping Weight	Service Forms
<b>Air pilot</b>					
<b>HGB-510-R1</b>	.42 gpm / 1.6 lpm	Remote (4mm tube)	None		SB-6-HGB-H
<b>HGB-510-R2</b>	.35 gpm / 1.3 lpm	Remote (4mm tube)	None		SB-6-HGB-H
<b>HGB-510-R4</b>	.2 gpm / .8 lpm	Remote (4mm tube)	None		SB-6-HGB-H
<b>HGB-510-R1-CO</b>	.42 gpm / 1.6 lpm	Remote (4mm tube)	None		SB-6-HGB-H
<b>HGB-510-R2-CO</b>	.35 gpm / 1.3 lpm	Remote (4mm tube)	None		SB-6-HGB-H
<b>HGB-510-R4-CO</b>	.2 gpm / .8 lpm	Remote (4mm tube)	None		SB-6-HGB-H
<b>845020</b>	3 gpm / 11.5 lpm	Hex key wrench	None		845020
<b>845004</b>	6 gpm / 23 lpm	Hex key wrench	Nipple, coupling & gauge 60 psi / 4 bar	9 lbs.	84500X

## Medium Pressure Fluid Regulators





Part Number	Capacity	Type	Gauge	Shipping Weight	Service Forms
<b>845001</b>	6 gpm / 23 lpm	Hex key wrench	Nipple, coupling & gauge 1000 psi / 70 bar	9 lbs.	84500X

# Fluid Regulators, Gauges & Heaters

## High Pressure Fluid Regulators

	Part Number	Wetted Parts	Inlet	Outlet	Inlet Pressure Min.	Inlet Pressure Max.	Outlet Pressure Min.	Outlet Pressure Max.
	845014	Carbon Steel / Tungsten carbide	3/8"npt(f)	3/8"npt(f)		3000 psi / 207 bar	400 psi / 28 bar	1250 psi / 86 bar
	845011	Stainless steel / Tungsten carbide	3/8"npt(f)	3/8"npt(f)		6000 psi / 414 bar	1000 psi / 70 bar	3000 psi / 207 bar
	845013	Stainless steel / Tungsten carbide	3/8"npt(f)	3/8"npt(f)		6000 psi / 414 bar	2000 psi / 140 bar	5000 psi / 345 bar
	845010	Stainless steel / Tungsten carbide	3/8"npt(f)	3/8"npt(f)		3000 psi / 207 bar	400 psi / 28 bar	1250 psi / 86 bar
	84-420	Stainless steel	1/4"npt(m)	1/4"npt(f)		3000 psi / 210 bar	300 psi / 21 bar	2000 psi / 139 bar
	84-520	Stainless steel	2 ea. 1/4"npt(m)	1/4"npt(f)		2000 psi / 140 bar	100 psi / 7 bar	900 psi / 62 bar

## Back Pressure Regulators (Low Pressure)

	Part Number	Wetted Parts	Inlet	Outlet	Inlet Pressure Min.	Inlet Pressure Max.	Outlet Pressure Min.	Outlet Pressure Max.
	84-501	Electroless nickel plated	1/2"npt(f)	1/2"npt(f)		150 psi / 10 bar	10 psi / .7 bar	140 psi / 10 bar
	84-404	Stainless steel	3/4npt(f)	3/4npt(f)		150 psi / 10 bar	10 psi / .7 bar	140 psi / 10 bar
	84-504	Stainless steel	1-1/4"npt(f)	1-1/4"npt(f)		150 psi / 10 bar	10 psi / .7 bar	140 psi / 10 bar
	84-601	Stainless steel (low shear)	1/2"npt(f)	1/2"npt(f)		200 psi / 14 bar	0 psi / 0 bar	130 psi / 9 bar
	845000	Stainless steel	3/8"npt(f)	3/8"npt(f)		200 psi / 14 bar	0 psi / 0 bar	200 psi / 14 bar
	845003	Stainless steel	1-1/4"npt(f)	1-1/4"npt(f)		200 psi / 14 bar	0 psi / 0 bar	200 psi / 14 bar
	HGBR-609	Stainless steel	1/4"npt(f)	1/4"npt(f)	30 psi / 2 bar	180 psi / 12.5 bar	0 psi / 0 bar	130 psi / 9 bar
	107750	Stainless steel	3/4"npt(f)	3/4"npt(f)				200 psi



# Fluid Regulators, Gauges & Heaters

## High Pressure Fluid Regulators

Part Number	Capacity	Type	Gauge	Shipping Weight	Service Forms
845014	3 gpm / 11.5 lpm	Hex key wrench	None	9 lbs.	84501X
845011	3 gpm / 11.5 lpm	Hex key wrench	None	9 lbs.	84501X
845013	6 gpm / 23 lpm	Hex key wrench	None		84501X
845010	3 gpm / 11.5 lpm	Hex key wrench	None		84501X
84-420	1 gpm / 3.8 lpm	T- handle	Optional gauge 101-3069 3000 psi / 207 bar		77-1908
84-520	1 gpm / 3.8 lpm	T- handle	Optional gauge 84-491 1000 psi / 70 bar		77-1908

## Back Pressure Regulators (Low Pressure)



Part Number	Capacity	Type	Gauge	Shipping Weight	Service Forms
84-501	7 gpm / 26 lpm	Key	Optional 84-40 connection & 83-1290 gauge 150 psi / 10 bar		77-1662
84-404	11 gpm / 42 lpm	Key	Optional 84-348 riser tube & 83-2744 gauge 200 psi / 13 bar		77-1889
84-504	11 gpm / 42 lpm	Key	Optional 84-348 riser tube & 83-2744 gauge 200 psi / 13 bar		77-1889
84-601	1 gpm / 3.8 lpm	Key	84-348 riser tube & 83-2744 gauge 200 psi / 13 bar		77-2629
845000	6 gpm / 23 lpm	Hex key	Nipple, coupling & gauge 300 psi / 21 bar	9 lbs.	84500X
845003	18.5 gpm / 70 lpm	Hex key	Nipple, coupling & gauge 300 psi / 21 bar	9 lbs.	84500X
HGBR-609	4.9 gpm / 18 lpm	Key	Riser tube & gauge GA-288 160 psi / 11 bar		SB-6-HGBR-A
107750		Key Low Shear	No gauge		

# Fluid Regulators, Gauges & Heaters

## Back Pressure Regulators (Medium Pressure)

	Part Number	Wetted Parts	Inlet	Outlet	Inlet Pressure Min.	Inlet Pressure Max.	Outlet Pressure Min.	Outlet Pressure Max.
	845002	Stainless steel	3/8"npt(f)	3/8"npt(f)		800 psi / 55 bar	0 psi / 0 bar	800 psi / 55 bar

## Back Pressure Regulators (High Pressure)

	Part Number	Wetted Parts	Inlet	Outlet	Inlet Pressure Min.	Inlet Pressure Max.	Outlet Pressure Min.	Outlet Pressure Max.
	84-421	Stainless steel	1/4"npt(f)	1/4"npt(m)		3000 psi / 207 bar	300 psi / 21 bar	2000 psi / 140 bar
	845012	Stainless steel	3/8"npt(f)	3/8"npt(f)		3000 psi / 207 bar	100 psi / 7 bar	3000 psi / 207 bar

# Fluid Regulators, Gauges & Heaters

## Back Pressure Regulators (Medium Pressure)

Part Number	Capacity	Type	Gauge	Service Forms
845002	6 gpm / 23 lpm	Hex key	Nipple, coupling & gauge 1000 psi / 70 bar	84500X

## Back Pressure Regulators (High Pressure)

Part Number	Capacity	Type	Gauge	Service Forms
84-421	1 gpm / 3.8 lpm	T- handle	Optional 101-3069 gauge 3000 psi / 207 bar	77-1909
845012	6 gpm / 23 lpm	Hex key	None	84501X

# Fluid Regulators, Gauges & Heaters

## Gun Mount Non-Circulating Regulators

Part Number	Description / Wetted Parts	Inlet	Outlet	Inlet Press. Min.	Inlet Press. Max.	Outlet Press. Min.	Outlet Press. Max.
84-585	Stainless steel low pressure	1/4" nps(m)	3/8" nps(f) sw	n/a	250 psi	0 psi	50 psi
HGS-5132	Stainless steel low pressure	1/8" npt(f)	3/8" nps(f) sw	50 psi	300 psi	2 psi	100 psi
HGS-5133	Stainless steel low pressure	1/8" npt(f)	1/4" nps(m) standpipe	50 psi	300 psi	2 psi	100 psi
HGS-5231	Stainless steel low pressure	1/8" npt(f)	Bayonet lock (q.d.)	50 psi	300 psi	2 psi	100 psi
HGS-5232	Stainless steel low pressure	1/8" npt(f)	3/8" nps(f) swivel	50 psi	300 psi	2 psi	100 psi
HGS-5233	Stainless steel low pressure	1/8" npt(f)	1/4" nps(m) standpipe	50 psi	300 psi	2 psi	100 psi
HGS-5239	Stainless steel low pressure	3/8" nps(f)	3/8" nps(m)	50 psi	300 psi	2 psi	100 psi
HGS-5242	Stainless steel	3/8" nps(m)	3/8" nps(f) sw	50 psi	300 psi	2 psi	100 psi

## Gun Mount Circulating Regulators

Part Number	Description / Wetted Parts	Inlet	Outlet	Inlet Press. Min.	Inlet Press. Max.	Outlet Press. Min.	Outlet Press. Max.
84-525	Stainless steel	1/4" nps(m)	3/8" nps(f) sw/ 1/4" nps(m)	n/a	250 psi	0 psi	50 psi
HGS-5112	Stainless steel	1/4" nps(m)	3/8" nps(f) sw	50 psi	300 psi	2 psi	100 psi
HGS-5113	Stainless steel	1/4" nps(m)	1/4" nps(m) standpipe	50 psi	300 psi	2 psi	100 psi
HGS-5122	Stainless steel	3/8" nps(m)	3/8" nps(f) sw	50 psi	300 psi	2 psi	100 psi
HGS-5211	Stainless steel	1/4" nps(m)	Bayonet lock (q.d.)	50 psi	300 psi	2 psi	100 psi
HGS-5212	Stainless steel	1/4" nps(m)	3/8" nps(f) sw	50 psi	300 psi	2 psi	100 psi
HGS-5221	Stainless steel	3/8" nps(m)	Bayonet lock (q.d.)	50 psi	300 psi	2 psi	100 psi
HGS-5222	Stainless steel	3/8" nps(m) x 2	3/8" nps(f) sw	50 psi	300 psi	2 psi	100 psi
HGS-5313	Stainless steel	1/4" nps(m)	1/4" nps(m) standpipe	50 psi	300 psi	2 psi	100 psi
84-261	s.s. Circulating Conn w/ Restrictor	3/8" nps(m)	3/8" nps(f) sw	0 psi 0 bar	200 psi	n/a	n/a
72-1823	s.s. Circulating Conn.	3/8" nps(m) x 2	3/8" nps(f)	0 psi 0 bar	200 psi	n/a	n/a

# Fluid Regulators, Gauges & Heaters

## Gun Mount Non-Circulating Regulators

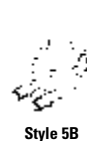

Part Number	Capacity	Type	Gauge	Style*	Service Forms
84-585	n/a	Manually adjusted	None	13B	77-2689
HGS-5132	2500 ml /min	Air pilot (remote)	None	5A,B & C	SB-6-403
HGS-5133	2500 ml /min	Air pilot (remote)	None	5A,B & C	SB-6-403
HGS-5231	2500 ml /min	Manual	None	5A,B & C	SB-6-403
HGS-5232	2500 ml /min	Manual	None	5A,B & C	SB-6-403
HGS-5233	2500 ml /min	Manual	None	5A,B & C	SB-6-403
HGS-5239	2500 ml /min	Manual	None	5A,B & C	SB-6-403
HGS-5242	2500 ml /min	Manual	None	5A,B & C	SB-6-403

## Gun Mount Circulating Regulators

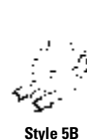

Part Number	Capacity	Type	Gauge	Style*	Service Forms
84-525	1/2 GPM	Spray gun mount	None	13B	77-2594
HGS-5112	2500 ml /min	Air pilot (remote)	None	5A,B & C	SB-6-403
HGS-5113	2500 ml /min	Air pilot (remote)	None	5A,B & C	SB-6-403
HGS-5122	2500 ml /min	Air pilot (remote)	None	5A,B & C	SB-6-403
HGS-5211	2500 ml /min	Manual	None	5A,B & C	SB-6-403
HGS-5212	2500 ml /min	Manual	None	5A,B & C	SB-6-403
HGS-5221	2500 ml /min	Manual	None	5A,B & C	SB-6-403
HGS-5222	2500 ml /min	Manual	None	5A,B & C	SB-6-403
HGS-5313	2500 ml /min	Manual tamper resistant	None	5A,B & C	SB-6-403
84-261	n/a	n/a	None	n/a	77-2096
72-1823	n/a	n/a	None	n/a	n/a

# Fluid Regulators, Gauges & Heaters

## Fluid Regulator Repair Kits

Regulator Part No.	Repair Kit	Diaphragm Kit	Valve & Seat Kit	Service Form
84-120	n/a	n/a	n/a	77-1417
84-320	n/a	6-1310	n/a	77-1486
84-345	6-221	n/a	n/a	77-1632
84-346	84-591	84-592	n/a	77-1758
84-404	n/a	6-1310	6-1312	77-1889
84-407	n/a	6-1310	n/a	77-1486
84-409	6-210	n/a	n/a	77-1915
84-410	84-591	84-592	n/a	77-1921
84-411	6-210	n/a	n/a	77-2011
84-412	6-221	n/a	n/a	77-1632
84-415 (OBS)	84-591	84-592	n/a	77-1758
84-420	6-1306	n/a	n/a	77-1908
84-421	6-1306	n/a	n/a	77-1909
84-501	n/a	6-1310	6-1311	77-1662
84-504	n/a	6-1310	6-1312	77-1889
84-520	6-1306	n/a	n/a	77-1908
84-525	n/a	6-1305	n/a	77-2594
84-585	n/a	6-1305	n/a	77-2689
84-598	6-525	6-525	6-525	77-2871
84-599 (obs)	6-526	6-526	6-526	77-2871
84-601	n/a	6-1309	n/a	77-2629
845000	863011	n/a	n/a	84500X
845001	863010	863003	863005	84500X
845002	863011	n/a	n/a	84500X
845003	863012	863003	863004	84500X
845004	863018	863003	863007	84500X
845010	863013	863008	863007	84501X
845011	863013	863008	863007	84501X

## Fluid Regulator Repair Kits

Regulator Part No.	Repair Kit	Diaphragm Kit	Valve & Seat Kit	Service Form
845012	863011	863003	863001	84500X
845013	863015	863008	863005	84501X
845014	863013	863008	863007	84501X
845020	n/a	n/a	n/a	845020
HGB-502-1	n/a	KK-4216	HGB-406-4-K	SB-6-375
HGB-508-1	n/a	KK-4216	HGB-406-4-K	SB-6-375
HGB-509-5-R38	n/a	HGB-422	HGB-426-00	SB-6-HGB-H
HGB-510-R2	n/a	HGB-424	HGB-426	SB-6-HGB-H
HGS-5112	KK-4456	n/a	n/a	SB-6-403
HGS-5113	KK-4456	n/a	n/a	SB-6-403
HGS-5122	KK-4456	n/a	n/a	SB-6-403
HGS-5132	KK-4456	n/a	n/a	SB-6-403
HGS-5133	KK-4456	n/a	n/a	SB-6-403
HGS-5211	KK-4456	n/a	n/a	SB-6-403
HGS-5212	KK-4456	n/a	n/a	SB-6-403
HGS-5221	KK-4456	n/a	n/a	SB-6-403
HGS-5222	KK-4456	n/a	n/a	SB-6-403
HGS-5231	KK-4456	n/a	n/a	SB-6-403
HGS-5232	KK-4456	n/a	n/a	SB-6-403
HGS-5233	KK-4456	n/a	n/a	SB-6-403
HGS-5239	KK-4456	n/a	n/a	SB-6-403
HGS-5242	KK-4456	n/a	n/a	SB-6-403
HGS-5313	KK-4456	n/a	n/a	SB-6-403

# Fluid Regulators, Gauges & Heaters



GA-288



237-765

## Fluid Pressure Gauges

Part No.	Capacity Pressure	Thread Size & Position		Notes
		Bottom	Back	
GA-73	30 psi	1/4" npt(m)		2" diameter
MA-25	35 psi / 2.5 bar	1/4" bspt		50 mm dia. – used on HGB-609-1.2R38 fluid regulators
237-765	100 psi		1/8" npt(m)	1-1/2" diameter stainless steel
83-2571	100 psi	1/4" npt(m)		2-11/16" diameter with stainless steel bourdon tube
GA-288	160 psi	1/4" npt(m)		2" diameter
84-246	200 psi	1/4" npt(m)		2-1/2" diameter with pulse diaphragm
84-491	1000 psi	1/4" npt(m)		2-1/2" diameter w / diaphragm
101-3069	3000 psi	1/4" npt(m)		2-7/64" diameter w / pulse diaphragm
873055	3000 psi		1/4" npt(m)	Stainless steel

## Liquid Filled Stainless Steel

Part No.	Capacity Pressure	Thread Size & Position		Notes
		Bottom	Back	
107-1433	2000 psi	1/4" npt(m)		Used on 101-1950 stainless steel pump assembly
107-1637	1000 psi	1/4" npt(m)		

## Riser Tubes (For Fluid Regulators / Gauges)

Part Number	Size	Size	Length	Materials	Max. Working Pressure	Where Used	Service Form
HGB-14	3/8" npt(m)	1/4" npt(f)	3 1/2"	303 Stn. Stl.	250 PSI	HGB and HGBR Series Regs and BPR's	SB-6-375 SB-6-HGB-H SB-6-HGBR-A
84-348	1/4" npt(m)	1/4" npt(f)	3"	303 Stn. Stl.	250 PSI	Reg's: 84-410, 84-320, 84-407, 84-409	77-1921, 77-1486 77-1486, 77-1915
84-40	1/4" npt(m)	1/4" npt(f)	3"	Brass	250 PSI	Reg's: 84-345, 84-346 84-411, 84-412	77-1632, 77-1758 77-2011, 77-1632

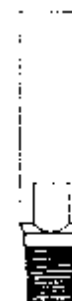

# Fluid Regulators, Gauges & Heaters



High pressure, lightweight (28 lbs), compact construction. Working capacity to 5000 psi and with adjustable thermostatic control from 60° to 250°F. The typical temperature rise with a flow of 32 fl. oz./min. while maintaining a temperature of 100% above ambient is 100°F. 1/2" npt(f) inlet and outlet ports. (CSA listed, CE approved)

Explosion Proof, Class 1, Division 1, Group D for Hazardous Locations.

**Capacity of fluid in heater:** 0.162 L  
**Fluid Passage Length:** 91.7"  
**Ports:** 1/2" npt(f)

## Fluid Heaters

Part Number	Max. Working Pressure	Temp Range	Wetted Parts	Voltage	Amperage	Mntg Hdwe	Wattage	Service Form
830000	5000 psi	60 - 250 Deg F	Stainless steel	120 vac	16.6 amps	Included	2000 Watts	83000X
830001	5000 psi	60 - 250 Deg F	Stainless steel	240 vac	8.33 amps	Included	2000 Watts	83000X
830002	5000 psi	60 - 250 Deg F	Stainless steel	440 vac	4.5 amps	Included	2000 Watts	83000X

## FRP Heater Kits

Part Number	Description
207-12351	115 volt mounting hardware kit, 2 fittings & hose – for mounting heaters to Unison (FRP) pump systems
207-12352	220 volt mounting hardware kit, 2 fittings & hose – for mounting heaters to Unison (FRP) pump systems



## **Air & Fluid Valves**

<b>BALL VALVES (LOW PRESSURE)</b>	<b>4-2</b>
<b>BALL VALVES (HIGH PRESSURE)</b>	<b>4-2</b>
<b>BALL VALVES (AIR VENT)</b>	<b>4-3</b>
<b>VA SERIES VALVES (AIR &amp; FLUID)</b>	<b>4-3</b>
<b>AIR ADJUSTMENT VALVES</b>	<b>4-4</b>
<b>PRESSURE SAFETY RELIEF VALVES</b>	<b>4-4</b>

# Air & Fluid Valves

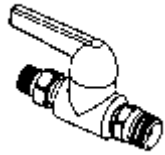

## Ball Valves (Low Pressure)

Part No.	Thread Sizes	Max. Working Pressure	Materials	Useage	Service Form
72-83030	1/4" m x 1/4" m •	250 psi	Die cast (zinc plated)	Air / Fluid	77-2806
72-84040	3/8" m x 3/8" m •	250 psi	Die cast (zinc plated)	Air / Fluid	77-2806
72-81414	1/4" f x 1/4" f	250 psi	Die cast (zinc plated)	Air / Fluid	77-2806
72-84030	3/8" m x 1/4" m •	250 psi	Die cast (zinc plated)	Air / Fluid	77-2806
72-81540	3/8" f x 3/8" m	250 psi	Die cast (zinc plated)	Air / Fluid	77-2806
73-81414	1/4" f x 1/4" f +	250 psi	Plated brass	3 Way Air / Fluid	77-2806
73-83030	1/4" m x 1/4" m • +	250 psi	Plated brass	3 Way Air / Fluid	77-2806
73-84040	3/8" m x 3/8" m • +	250 psi	Plated brass	3 Way Air / Fluid	77-2806
0115-010334	3/8" bsp(f)	145 psi	Plated brass	2 Way Air	n/a

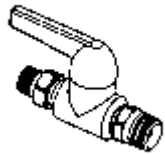

## Ball Valves (High Pressure)

Part No.	Thread Sizes	Max. Working Pressure	Materials	Useage	Service Form
72-13030	1/4" m x 1/4" m •	4000 psi	Brass/steel	Fluid	77-2806
72-14040	3/8" m x 3/8" m •	4000 psi	Brass/steel	Fluid	77-2806
72-14030	3/8" m x 1/4" m •	4000 psi	Brass/steel	Fluid	77-2806
172-33535	1/4" m x 1/4" m •	4000 psi	Stainless steel	Fluid	77-2806
172-34545	3/8" m x 3/8" m •	4000 psi	Stainless steel	Fluid	77-2806
172-31414	1/4" f x 1/4" f	4000 psi	Stainless steel	Fluid	77-2806
0114-019091	1/4" bspt(fbe)	4000 psi		Fluid	n/a

• m = male thread (universal thread for use with "npt or" nps connections.)

+ = 1/4" npt(f) inlet fittings

f = female thread (npt)

fbe = female both ends

# Air & Fluid Valves



237-269, 73-91100, 73-91300  
Vented Ball Valve (Air)

## Ball Valves (Air Vent)

Part No.	Thread Sizes	Max. Working Pressure	Materials	Useage	Service Form
237-269	1/2" npt (fbe)	250 psi	Brass	Air	n/a
73-91100	3/8" npt (fbe)	250 psi	Brass	Air / Vent	n/a
73-91300	3/4" npt (fbe)	250 psi	Brass	Air / Vent	n/a



VA Series  
Ball Valves

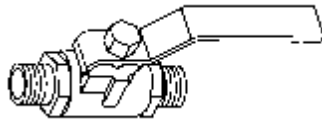

VA-595  
Vented Ball Valve (Air)

## VA Series Valves (Air & Fluid)

Part No.	Thread Sizes	Max. Working Pressure	Materials	Useage	Service Form
VA-527	3/8" npt(m) x 3/8" nps(m)	500 psi	Stainless steel	Air / Fluid	SB-11-119
VA-528	3/8" nps(m) x 3/8" npt(f)	500 psi	Stainless steel	Air / Fluid	SB-11-119
VA-540	3/8" nps(m) x 3/8" npt(m)	500 psi	Brass	Air / Fluid	SB-11-119
VA-542	1/4" nps(m) x 1/4" npt(m)	500 psi	Brass	Air / Fluid	SB-11-119
VA-595	1/2" npt(mbe)	175 psi	Brass	Air / Vented	SB-11-119

m = male thread  
f = female thread (npt)  
fbe = female both ends  
mbe = male both ends

# Air & Fluid Valves



873409

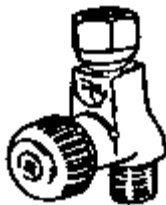

HAV-500  
Air Valve



HAV-501  
Air Valve



P-H-5516  
In Line Air Valve

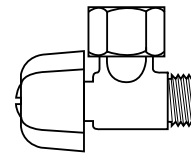

73-159

## Air Adjusting Valves/Needle Valves/Cheater Valves

Part Number	Type	Inlet Size	Outlet Size	W or W/O Gauge Assy.	Max. Working Pressure	Recommended Range	Service Form
873409	Straight	1/4" npt(fbe)	1/4" npt(fbe)	W/O	100 psi	0-100 psi	n/a
HAV-500	Straight	1/4" nps(m)	1/4" nps(f)	W/O	125 psi	0-125 psi	SB-11-119
HAV-501	Straight	1/4" nps(m)	1/4" nps(f)	W / gauge	125 psi	0-125 psi	SB-11-119
73-159	90 Degree	1/4" nps(m)	1/4" nps(f)	W/O	250 psi	0-125 psi	n/a
P-H-5516	45 Degree	1/4" nps(m)	1/4" nps(f)	W/O	250 psi	0-125 psi	SB-11-119

fbe = Female Both Ends



Safety Valves

## Pressure Safety Relief Valves

Part No.	Pressure Rating	npt Male Thread	Service Form	Notes
TIA-4326	15 psi	1/8"	SB-11-661	Used on 85-435 regulator and KK-4980 regulator kit
TIA-5040	40 psi	1/4"	n/a	Used on 183- tanks with extra-sensitive regulators
TIA-4355	55 psi	1/4"	SB-11-661	Used on KB Series cups
TIA-5080	80 psi	1/4"	SB-11-661	Replacement for TIA-4380—used on 2.8 gallon pressure tanks
TIA-5110	110 psi	1/4"	SB-11-661	Used on 110 psi ASME code tanks
85-243	55 psi	1/8"	n/a	Used on 80-295 2-qt. cups

# Hose, Connections & Assemblies

<b>REUSABLE CONNECTIONS</b>	<b>5-2</b>
<b>UNDERSTANDING PRESSURE DROP</b>	<b>5-3</b>
<b>TECHNICAL DATA</b>	<b>5-4</b>
<b>BULK AIR HOSE &amp; CONNECTIONS</b>	<b>5-5</b>
<b>BULK FLUID HOSE &amp; CONNECTIONS</b>	<b>5-8</b>
<b>TUBING &amp; CONNECTIONS</b>	<b>5-9</b>
<b>AIR HOSE ASSEMBLIES</b>	<b>5-12</b>
<b>FLUID HOSE ASSEMBLIES</b>	<b>5-14</b>
<b>FRP HOSE ASSEMBLIES</b>	<b>5-19</b>
<b>CATALYST HOSE ASSEMBLIES (FRP)</b>	<b>5-21</b>

# Hose, Connections & Assemblies

## Reusable Connections



Type A. Plated Brass



Type B. Plated Brass



Type C. Plated Brass

## How to Install Compression Sleeve Type Connections

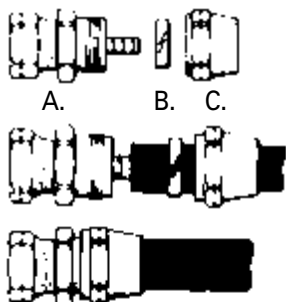

Place a matching double male nipple in a vise and tighten. Screw swivel nut onto fitting and tighten. Remove nut and sleeve from connector. Cut hose end square and slide nut over hose approximately 2 inches back from cut. Spread sleeve ring just enough to slide over hose easily. Push hose onto connector body, twisting hose slightly as you push to insure proper seating. Slide sleeve forward and tighten nut until connector body begins to turn. Remove double male nipple—hose and connection are ready to use. Tools required: vise, double male nipple, adjustable wrench, knife.

This connection consists of three (3) pieces:

- A. Swivel nut and connector body
- B. Sleeve
- C. Nut

## How to Install Punch-Lok Type Connections

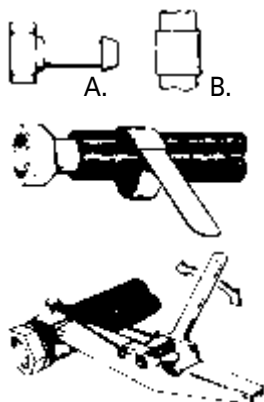

Place a matching double male nipple in a vise and tighten. Screw swivel nut onto fitting and tighten. Cut hose end square and slide Punch-Lok strap onto hose about 3 inches from cut end. Push hose onto connection tailpiece and slide strap forward to approximately 1/4 inch from connector body nut. Insert end of strap into Punch-Lok tool and tighten. Do not overtighten or strap will cut hose. Hold tension on strap and position punch. Strike punch with hammer to lock strap in place. The Punch-Lok tool, when moved up and down will sever excess strap. Remove double male nipple, and hose connection is complete. Tools required: Vise, Punch-Lok tool, double male nipple, adjustable wrench, knife, hammer.

This connection consists of two (2) pieces:

- A. Swivel nut with tailpiece
- B. Punch-Lok strap

E.V.A. = Ethylene Vinyl Acetate    E.P.D.M. = Ethylene Propylene Diene Rubber    s.s. = Stainless steel  
 Steel pltd = Steel plated    Brass pltd = Brass plated    n/a = Not available

# Hose, Connections & Assemblies

## Understanding Pressure Drop

### Pressure Drop Basics

Understanding pressure drop requires a basic knowledge of cfm (cubic feet per minute) and psi (pounds per square inch). cfm refers to the given volume of air that flows past a given point in one minute. psi is the amount of force pushing the cubic foot of air through the hose or tool.

The amount of air that a tool consumes will remain constant for a given set of conditions. Pressure will always drop when the tool is turned on and when the air begins to flow through the hose. In addition, pressure drop will vary in relation to any adjustment made on the tool.

The same pressure loss principles apply when moving fluid through a hose. Be sure to consider pressure loss when choosing fluid hose and fittings.

### Pressure Drop Points

Losses in pressure (psi) are dependent on the variables of hose length, hose diameter, volume (cfm), and the number and design of quick disconnects. To minimize the effects of pressure drop and the resulting lack of volume, consider the following:

- Frictional resistance between the fluid and the walls of the hose
- Internal resistance (shear)—fluid moves faster through the center of the hose and slower against the walls
- Change in direction of air or fluid through the system
- Volume at any given time as determined by back pressure
- The number of system connections, adapters, nipples, valves, filters, and air and fluid controls
- Hose i.d.—use the minimum i.d. necessary for each application
- Hose length—pressure drop is proportional to hose length
- Surface of the hose's inner tube—a rough surface can increase pressure drop up to 50%

### Pressure Drop Chart Hose Sizes: 1/4" to 1" I.D.

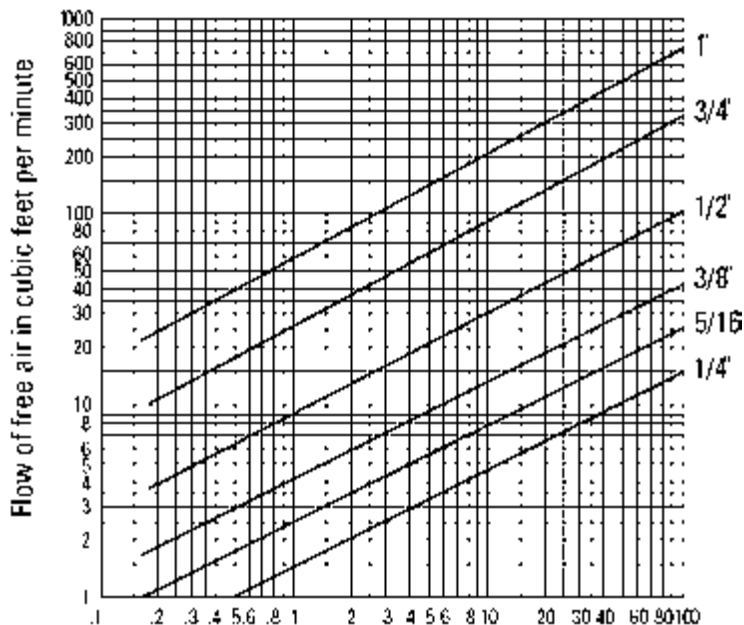

Pressure drop in pounds per sq. in., per 100 ft. of hose

To determine pressure drops for hose lengths other than 100 ft.:

$$(\text{Pressure Drop Chart Figure}) \times \frac{(\text{Ft. of Hose})}{100} = \text{Pressure drop for hose used}$$

### Technical Data

This chart is for approximating and should only serve as a guide in sizing air hose. Pressure drop is directly proportional to hose lengths. That means that if hose length doubles, for example, pressure drop doubles.

### Example:

- 100 ft. x 1/2 in. i.d. hose at 40 cfm has a pressure loss of 17.5 psi.
- 200 ft. x 1/2 in. i.d. will lose 35 psi.
- 50 ft. x 1/2 in. i.d. will lose between 8 to 9 psi.

E.V.A. = Ethylene Vinyl Acetate    E.P.D.M. = Ethylene Propylene Diene Rubber    s.s. = Stainless steel  
Steel pltd = Steel plated    Brass pltd = Brass plated    n/a = Not available

# Hose, Connections & Assemblies

## Technical Data

### Chemical Resistance Chart

TYPES OF SOLVENTS, THINNERS, CATALYSTS	FLUIDALL™ FLUID HOSE	HIGH PRESSURE AIRLESS	Nylon TUBING	POLYETHYLENE TUBING
Drying Oils, Alkyds (Mineral Spirits)(Naphtha)	●■	●■	●■	●
Phenolic Varnishes, Epoxy Esters Coal Tars, 1 Pkg. Urethanes (Naphtha – Toluene Blend)	●■	●■	●■	●
Chlorinated Rubber, Chlor. Rub. Zinc Rich Silicones, "Hypalon" (Toluene), (Xylene)	●■	●■	●■	○
Phenolics, Epoxies, Epoxy Zinc Rich Vinyl Alkyds (Toluene – MEK Blend)	●■	●■	●■	○
Vinyls, Vinyl-Acrylics, Polyesters, Polyester Zinc Rich, (MEK), (MIBK)	●■	●■	●■	○
Lacquers, 2 Pkg. Urethanes High Gloss Enamels (Ketone – Ester Blend)	●■	●■	●■	○
PV Acetate, Polyacrylics Latex, Zinc Silicates, (Water Based)	●	●	●	●
Water-Based	●	●	●	-
Aromatic, Solvent Based	-	●	-	-
Chlorinated, Solvent Based	●	●	●	-

**KEY TO CHART:**

**Material at Room Temperature:** ● Continuous Service ○ Intermittent Service **Heated Material:** ■ Continuous Service

### Common Terms

(f)	Female Thread	sw	Swivel
(fbe)	Female Both Ends	mwp	Maximum Working Pressure
(m)	Male Thread	mpa	? x 145 = P.S.I.
(mbe)	Male Both Ends		
cfm	Cubic Feet Per Minute	<b>Metric Conversion</b>	
i.d.	Inside Diameter	1 cm. = 0.3937 in.	
J.I.C.	Joint Industrial Council	1 bar = 14.5 psi.	
nps	National Pipe Straight	1 liter = 0.264 gal. (U.S.)	
npt	National Pipe Tapered	1 kg. = 2.205 lb.	
o.d.	Outside Diameter	1 meter = 3.28 ft.	
psi	Pounds Per Square Inch	1 millimeter = 0.03937 inches	
s.s.	Stainless Steel		

E.V.A. = Ethylene Vinyl Acetate    E.P.D.M. = Ethylene Propylene Diene Rubber    s.s. = Stainless steel  
Steel pltd = Steel plated    Brass pltd = Brass plated    n/a = Not available



# Hose, Connections & Assemblies

## Premium Spray Finishing Air Hose (Smooth Cover)

### Recommended Use

Premium spray finishing air hose. Class B oil resistance. Designed for all finishing operations as well as rugged industrial applications, especially applications requiring lubricants in the airline supply or where oil and grease are present in the environment. Excellent for use with water and water-based materials. Temperature range from -40°F to +200° F (max).

### Tube

EPDM, Class B oil resistant.

### Reinforcement

High tensile strength spiral reinforcement. Specially designed for maximum flexibility (under pressure) and maximum coupling retention.

### Cover

EPDM, red, smooth.  
Abrasion resistant. Oil resistant.



### Bulk Hose Chart – Smooth Cover

SIZES AVAILABLE		BULK HOSE NUMBER	MAXIMUM WORKING PRESSURE (psi)	BEND RADIUS	STD. REEL	APPROX. SHIPPING WEIGHT	
I.D.	o.d.				LENGTH IN FT.	1 PIECE REELS	BASED ON FEET PER REEL
1/4"	1/2"	71-10000	250	2 3/4"	500	50 lbs.	10 lbs.
5/16"	5/8"	71-11000	250	3"	500	87 lbs.	16.2 lbs.
3/8"	11/16"	71-12000	250	3 1/2"	500	96 lbs.	18 lbs.
1/2"	7/8"	71-13000	250	5"	300	86 lbs.	26.8 lbs.
3/4"	1 1/8"	71-14000	250	6"	300	112 lbs.	35 lbs.

## Air Hose Grounded with Static Wire

### Recommended Use

Premium finishing air hose. Oil resistance, rating Class B. Designed for all finishing operations as well as rugged industrial applications. Static wire between tube and cover prevents build-up of static electricity. Commonly used with atomizing spray guns, electrostatic spray guns and equipment that requires grounding for safety purposes. Temperature range from -40° F to +200° F.

### Tube

EPDM, Class B oil resistant.

### Reinforcement

High tensile strength synthetic spiral reinforcement. Specially designed for maximum flexibility (under pressure) and maximum coupling retention.

### Cover

EPDM, red, smooth.  
Abrasion resistant. Oil resistant.



### Bulk Hose Chart – Smooth Cover

SIZES AVAILABLE		BULK HOSE NUMBER	MAXIMUM WORKING PRESSURE (psi)	BEND RADIUS	STD. REEL	APPROX. SHIPPING WEIGHT	
I.D.	o.d.				LENGTH IN FT.	1 PIECE REELS	BASED ON FEET PER REEL
5/16"	.618"	71-20000	250	3"	500	87 lbs.	17.4 lbs.
3/8"	.701"	71-21000	250	3.5"	500	96 lbs.	19.2 lbs.

*Recommended hose connection 72-1317-1/4" nps(f), 72-1325-1/4" nps(f)*

E.V.A. = Ethylene Vinyl Acetate    E.P.D.M. = Ethylene Propylene Diene Rubber    s.s. = Stainless steel  
Steel pltd = Steel plated    Brass pltd = Brass plated    n/a = Not available

# Hose, Connections & Assemblies

## Connections for Premium & Static Wire Air Hose

**Type A. Plated Brass**

**Type B. Plated Brass**

**Type C. Plated Brass**

Hose Size		For Bulk Hose No.	Connections		Compression Sleeve	Type
i.d.	o.d.		Thread	Part No.		
1/4"	1/2"	71-10000	1/4" nps(f)	72-1303	HC-20-K10	A
			3/8" nps(f)	72-1306	HC-20-K10	A
			3/8" nps(f)s.s.	72-2143*	72-854-5	A
5/16"	5/8"	71-11000 71-20000	1/4" nps(f)	72-1317	HC-12-K10	A
			1/4" npt(m)	72-1478	HC-12-K10	B
			3/8" nps(f)	72-1320	HC-12-K10	A
3/8"	11/16"	71-12000	1/4" nps(f)	72-1325	HC-23-K10	A
			3/8" nps(f)	72-1328	HC-23-K10	A
			3/8" nps(f)s.s.	72-2146*	72-854-5	A
1/2"	7/8"	71-13000	3/8" nps(f)	72-1333	HC-33	A
			1/2" nps(f)	72-1334	HC-33	A
			1/2" nps(f)	72-954†*	—	C
3/4"	1 3/16"	71-14000	3/4" nps(f)	72-1336†	—	C
			3/4" nps(f)	72-417†	—	C
			3/4" nps(f)	72-955†*	—	C
			3/4" nps(f)	72-1935	—	—
<b>Ergoflex™ Air Hose Connections</b>						
3/8"	.646"	71-31000	1/4" nps(f)	72-2008	HC-12-K10	A

†Punch-Lok Connection    \*Stainless Steel tailpiece

**SEE PAGE 5-12 FOR PREMIUM & STATIC WIRE AIR HOSE ASSEMBLIES**

 E.V.A. = Ethylene Vinyl Acetate    E.P.D.M. = Ethylene Propylene Diene Rubber    s.s. = Stainless steel  
 Steel pltd = Steel plated    Brass pltd = Brass plated    n/a = Not available

# Hose, Connections & Assemblies

## Lightweight ErgoFlex™ Air Hose (Smooth Cover)

### Recommended Use

Binks ErgoFlex™ HLVP Hose is suitable for use with all kinds of air-operated equipment, including those requiring lubricant in the air line, or in environments where oil and grease are present. Temperature range from -40° F to +200° F (max).



### Tube

Black EPDM, Class B oil resistant.

### Reinforcement

Synthetic yarn – Spiral reinforcement.

### Cover

Tan EPDM, smooth, Class C oil resistant.

### Bulk Hose Chart – Smooth Cover

SIZES AVAILABLE		BULK HOSE NUMBER	MAXIMUM WORKING PRESSURE (psi)	BEND RADIUS	STD. REEL	APPROX.	HOSE WEIGHT PER 100 FEET
I.D.	o.d.				LENGTH IN FT. 1 PIECE REELS	SHIPPING WEIGHT BASED ON FEET PER REEL	
3/8"	.646"	71-31000	125	3 1/2"	500	70 lbs.	12.8 lbs.

## Connections for Ergoflex™ Air Hose



Type A. Plated Brass

Hose Size		For Bulk Hose No.	Connections		Compression Sleeve	Type
i.d.	o.d.		Thread	Part No.		
3/8"	.646"	71-31000	1/4" nps(f)	72-2008	HC-12-K10	A

**SEE PAGE 5-13 FOR ERGOFLEX™ HOSE ASSEMBLIES**

E.V.A. = Ethylene Vinyl Acetate    E.P.D.M. = Ethylene Propylene Diene Rubber    s.s. = Stainless steel  
 Steel pltd = Steel plated    Brass pltd = Brass plated    n/a = Not available

# Hose, Connections & Assemblies

## Fluidall™ Fluid Hose (Nylon Lined, Maximum Versatility)

### Recommended Use

Premium, versatile fluid hose, for finishing operations plus a wide range of fluid applications. Fluidall™ is ideal for resins and solvents contained in epoxies, urethanes, alkyds, primers, acrylics, polyesters, silicones, bitumastic coatings, oil and water based paints, lacquers, alcohol and latex coatings. Temperature range from 0° F to +190°F (max).



### Tube

Nylon.

### Reinforcement

High tensile synthetic braid. Specially designed for maximum flexibility (under pressure) and maximum coupling retention.

### Cover

Black, synthetic, smooth rubber. Class B oil resistant.

### Bulk Hose Chart – Smooth Cover

SIZES AVAILABLE		BULK HOSE NUMBER	MAXIMUM WORKING PRESSURE (psi)	BEND RADIUS	STD. REEL	APPROX.	HOSE WEIGHT PER 100 FEET
I.D.	o.d.				LENGTH IN FT. 1 PIECE REELS	SHIPPING WEIGHT BASED ON FEET PER REEL	
1/4"	1/2"	71-280	500	3"	500	43 lbs.	8 lbs.
3/8"	11/16"	71-282	500	3 1/2"	500	83 lbs.	15 lbs.
1/2"	7/8"	71-283	750	5"	300	74 lbs.	22 lbs.
3/4"	1 3/16"	71-284	750	8"	300	118 lbs.	36 lbs.
1"	1 1/2"	71-285	750	12"	300	168 lbs.	53 lbs.

## Connections for Fluidall™ Fluid Hose

Hose Size		For Bulk Hose No.	Connections		Compression Sleeve	Type
i.d.	o.d.		Thread	Part No.		
1/4"	1/2"	71-280	1/4" nps(f)	72-1303	HC-20-K10	A
			3/8" nps(f)	72-1306	HC-20-K10	A
			3/8" nps(f) s.s.	72-2143*	72-854-5	A
3/8"	11/16"	71-282	1/4" nps(f)	72-1325	HC-23-K10	A
			3/8" nps(f)	72-1328	HC-23-K10	A
			3/8" nps(f) s.s.	72-2146*	72-856-5	A
1/2"	7/8"	71-283	3/8" nps(f)	72-1333	HC-33	A
			1/2" nps(f)	72-1334	HC-33	A
			1/2" nps(f)	72-954†		C
3/4"	1 3/16"	71-284	3/4" nps(f)	72-1336†		C
			3/4" nps(f)	72-417†		C
			3/4" nps(f)	72-955†*		C
			3/4" nps(f)	72-1935		—
1"	1 1/2"	71-285	1" nps(f)	72-418†		C
			1" nps(f)	72-956*		C
			1" nps(f)	72-1936		—



Type A. Plated Brass



Type B. Plated Brass



Type C. Plated Brass

†Punch-Lok Connection \*Stainless Steel tailpiece

### SEE PAGE 5-14 FOR FLUIDALL™ HOSE ASSEMBLIES

E.V.A. = Ethylene Vinyl Acetate    E.P.D.M. = Ethylene Propylene Diene Rubber    s.s. = Stainless steel  
 Steel pltd = Steel plated    Brass pltd = Brass plated    n/a = Not available

# Hose, Connections & Assemblies

## Tubing & Connections

### Nylon Tubing & Connections

Size	Tubing No.	Max. Working Pressure (psi)		Connection Part No.	Connection Description	Type
		@ 70 DEG. F.	@ 150 DEG. F.			
1/8" i.d. x .225" o.d.	71-226	475	190	PLH-1838-SS	s.s. 3/8" nps(f) swivel	E
				72-1677	Brass 1/4" nps(f) swivel	E
3/16" i.d. x 1/4" o.d.	71-230	225	190	PLH-31638-SS	s.s. 3/8" nps(f) swivel	E
				72-1729	Brass 3/8" nps(f) swivel	E
				72-1793	s.s. 3/8" nps(f) swivel w/ spring guard	D
				72-1679	Brass 1/4" nps(f) swivel	E
				72-1747	Brass 1/4" nps(f) swivel w. Spring guard	D
				72-1789	s.s. 1/4" nps(f) swivel	E
				72-1792	s.s. 1/4" nps(f) swivel w. Spring guard	D
1/4" i.d. x .350" o.d.	71-227	225	190	72-1680	Brass 1/8" npt(m)	E
				72-1681	Brass 1/4" nps(f) swivel	E
				72-1683	Brass 3/8" nps(f) swivel	E
				72-1687	Brass 1/4" nps(f) swivel w/ spring guard	D
				72-1689	Brass 3/8" nps(f) swivel w/ spring guard	D
				72-1799	s.s. 1/4" nps(f) swivel	E
				72-1800	s.s. 1/4" nps(f) swivel w/ spring guard	D
				72-1801	s.s. 3/8" nps(f) swivel	E
				72-1802	s.s. 3/8" nps(f) swivel w/ spring guard	D
3/8" i.d. x 1/2" o.d.	71-229	200	140	72-1685	Brass 3/8" nps(f) swivel	E
				72-1811	s.s. 1/4" nps(f) swivel	E
				72-1812	s.s. 3/8" nps(f) swivel	E



**TYPE D**  
Plated brass or stainless steel



**TYPE E**  
Plated brass or stainless steel

**SEE PAGE 5-16 FOR NYLON TUBE ASSEMBLIES**

E.V.A. = Ethylene Vinyl Acetate    E.P.D.M. = Ethylene Propylene Diene Rubber    s.s. = Stainless steel  
Steel pltd = Steel plated    Brass pltd = Brass plated    n/a = Not available

5

# Hose, Connections & Assemblies

## Tubing & Connections

### Polyethylene Tubing & Connections

Size	Tubing No.	Max. Working Pressure (psi)	Connection Part No.	Connection Description	Type
.175" i.d. x 1/4" o.d.	H-2339	125	P-HC-4728	Brass-alum-steel 1/4" nps(f) swivel	E
			P-HC-4221	Brass-alum-steel 1/4" nps(f) swivel w/ spring guard	D
			237-247	Brass elbow 1/4" npt(m)	Push-in
			237-250	Brass elbow 1/8" npt(m)	Push-in
			107-1636	s.s. elbow 1/4" npt(m)	E
1/4" i.d. x 3/8" o.d.	H-2338	125	72-1579	Brass 1/4" nps(f) swivel	E
			72-1581	Brass 3/8" nps(f) swivel	E
			72-1583	Brass 1/4" nps(f) swivel w/ spring guard	D
			72-1585	Brass 3/8" nps(f) swivel w/ spring guard	D
			72-1839	s.s. 3/8" nps(f) swivel	E
			72-1968	s.s. 1/4" nps(f) swivel	E
			72-1983	s.s. 1/4" nps(f) swivel w/ spring guard	D
			72-2060	s.s. 3/8" nps(f) swivel w/ spring guard	D
			54-4976	Push-lok 1/4" nps(f)*	E
			54-4975	Push-lok 1/8" npt(m)*	E
237-902	Polypropylene Elbow 1/4" npt(m)	E			

### E.V.A. Tubing & Connections

Size	Tubing No.	Max. Working Pressure (psi)	Connection Part No.	Connection Description	Type
1/8" i.d. x 5/16" o.d.	71-201	100	102-3031	316 s.s. 1/4" (f) swivel w/spring guard	D
5/16" i.d. X 17/32" o.d.	71-508	250	72-1646	416 s.s. 1/4" nps(f) swivel w/spring guard	D
3/8" i.d. x 19/32" o.d.	71-509	250	102-3033 connection & 72-1367 nut	316 s.s. 3/8" nps(f)	E

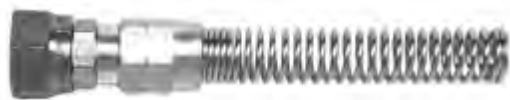

**TYPE D**  
Plated brass or stainless steel



**TYPE E**  
Plated brass or stainless steel

**SEE PAGE 5-21 FOR E.V.A. HOSE ASSEMBLIES**

E.V.A. = Ethylene Vinyl Acetate    E.P.D.M. = Ethylene Propylene Diene Rubber    s.s. = Stainless steel  
Steel pltd = Steel plated    Brass pltd = Brass plated    n/a = Not available

# Hose, Connections & Assemblies

## Tubing & Connections

### PTFE Tubing & Connections

Size	Tubing No.	Max. Working Pressure (psi)	Connection Part No.	Connection Description	Type
1/8" i.d. x 1/4" o.d.	71-248	140	237-250	Brass elbow 1/8"npt(m)	Push-in
			237-247	Brass elbow 1/4"npt(m)	Push-in
			72-1944	Brass 1/4"nps(f) swivel	E
			107-1636	s.s. elbow 1/4"npt(m)	E
			72-1945	s.s. 3/8"nps(f) swivel	E
3/16" i.d. x 5/16" o.d.	71-209	140	72-1577	Brass 1/4"nps(f) swivel	E
			72-1730	Brass 3/8"nps(f) swivel	E
1/4" i.d. x 3/8" o.d.	71-204	140	54-4975	Push-lok 1/8" npt(m)*	E
			72-1579	Brass 1/4"nps(f) swivel	E
			72-1583	Brass 1/4"nps(f) swivel w/ spring guard	D
			54-4976	Push-lok 1/4" nps(f)*	E
			72-1968	s.s. 1/4"nps(f) swivel	E
			72-1983	s.s. 1/4"nps(f) swivel w/ spring guard	D
			72-1581	Brass 3/8"nps(f) swivel	E
			72-1585	Brass 3/8"nps(f) swivel w/ spring guard	D
			72-1839	s.s. 3/8"nps(f) swivel	E
72-2060	s.s. 3/8"nps(f) swivel w/ spring guard	D			
*plastic & plated steel					
3/8" i.d. x 1/2" o.d.	71-207	140	237-902	Polypropylene elbow 1/4"npt(m)	E
			72-1811	s.s. 1/4"nps(f) swivel	E
			72-1685	Brass 3/8"nps(f) swivel	E
			72-1812	s.s. 3/8"nps(f) swivel	E

### Polyurethane Tubing & Connections

Size	Tubing No.	Max. Working Pressure (psi)	Connection Part No.	Connection Description	Type
1/4" i.d. x 3/8" o.d.	54-4987	100 (Red)	54-4975	Push-lok 1/8"npt(m)*	—
			54-4976	Push-lok 1/4"nps(f)*	—
			72-1579	Brass 1/4"nps(f) swivel	E
			72-1583	Brass 1/4"nps(f) swivel w/ spring guard	D
			72-1968	s.s. 1/4"nps(f) swivel	E
			72-1983	s.s. 1/4"nps(f) swivel w/ spring guard	D
			72-1581	Brass 3/8"nps(f) swivel	E
			72-1585	Brass 3/8"nps(f) swivel w/ spring guard	D
			72-1839	s.s. 3/8"nps(f) swivel	E
72-2060	s.s. 3/8"nps(f) swivel w/ spring guard	D			

\*plastic & plated steel



**TYPE D**  
Plated brass or stainless steel



**TYPE E**  
Plated brass or stainless steel

**SEE PAGE 5-13 FOR  
POLYURETHANE TUBE  
ASSEMBLIES**

E.V.A. = Ethylene Vinyl Acetate    E.P.D.M. = Ethylene Propylene Diene Rubber    s.s. = Stainless steel  
Steel pltd = Steel plated    Brass pltd = Brass plated    n/a = Not available

# Hose, Connections & Assemblies

## Air Hose Assemblies

### Premium Air Hose Assemblies (Low Pressure)

Part Number	Bulk Hose No.	Size	Max. Working Pressure	Tube Material	Connection Part No.	Threads	Connection Material
71-1101	71-10000	1/4" i.d. x 1/2" o.d. x 5 ft.	250 psi	E.P.D.M.	72-1303	1/4" nps(f)	Brass pltd
71-1105	71-10000	1/4" i.d. x 1/2" o.d. x 25 ft.	250 psi	E.P.D.M.	72-1303	1/4" nps(f)	Brass pltd
71-1106	71-10000	1/4" i.d. x 1/2" o.d. x 50 ft.	250 psi	E.P.D.M.	72-1303	1/4" nps(f)	Brass pltd
71-1201	71-11000	5/16" i.d. x 5/8" o.d. x 5 ft.	250 psi	E.P.D.M.	72-1317	1/4" nps(f)	Brass pltd
71-1203	71-11000	5/16" i.d. x 5/8" o.d. x 15 ft.	250 psi	E.P.D.M.	72-1317	1/4" nps(f)	Brass pltd
71-1205	71-11000	5/16" i.d. x 5/8" o.d. x 25 ft.	250 psi	E.P.D.M.	72-1317	1/4" nps(f)	Brass pltd
71-1206	71-11000	5/16" i.d. x 5/8" o.d. x 50 ft.	250 psi	E.P.D.M.	72-1317	1/4" nps(f)	Brass pltd
71-1209	71-11000	5/16" i.d. x 5/8" o.d. x 6 ft.	250 psi	E.P.D.M.	72-1317	1/4" nps(f)	Brass pltd
71-1355	71-12000	3/8" i.d. x 11/16" o.d. x 25 ft.	250 psi	E.P.D.M.	72-1325	1/4" nps(f)	Brass pltd
71-1356	71-12000	3/8" i.d. x 11/16" o.d. x 50 ft.	250 psi	E.P.D.M.	72-1325	1/4" nps(f)	Brass pltd

### Air Hose Assemblies (Grounded with Static Wire)

Part Number	Bulk Hose No.	Size	Max. Working Pressure	Tube Material	Connection Part No.	Threads	Connection Material
71-2803	71-20000	5/16" i.d. x 5/8" o.d. x 25 ft.	250 psi	E.P.D.M.	72-1317	1/4" nps(f)	Brass pltd
71-2810	71-20000	5/16" i.d. x 5/8" o.d. x 35 ft.	250 psi	E.P.D.M.	72-1317	1/4" nps(f)	Brass pltd
71-2804	71-20000	5/16" i.d. x 5/8" o.d. x 50 ft.	250 psi	E.P.D.M.	72-1317	1/4" nps(f)	Brass pltd

E.V.A. = Ethylene Vinyl Acetate    E.P.D.M. = Ethylene Propylene Diene Rubber    s.s. = Stainless steel  
 Steel pltd = Steel plated    Brass pltd = Brass plated    n/a = Not available



# Hose, Connections & Assemblies

## Air Hose Assemblies

### Ergoflex Air Hose Assemblies

Part Number	Bulk Hose No.	Size	Max. Working Pressure	Tube Material	Connection Part No.	Threads	Connection Material
71-31101	71-31000	.390 i.d. x .650 o.d. x 25 ft.	200 psi	E.P.D.M.	72-2008	1/4" nps(f)	Brass pltd
71-31103	71-31000	.390 i.d. x .650 o.d. x 6 ft.	200 psi	E.P.D.M.	72-2008	1/4" nps(f)	Brass pltd
71-31104	71-31000	.390 i.d. x .650 o.d. x 35 ft.	200 psi	E.P.D.M.	72-2028	1/4" nps(f)	Brass pltd

### 1/4" I.D. Air Tubing Assemblies (Low Pressure – Air Assist Supply)

Part Number	Bulk Hose No.	Size	Max. Working Pressure	Tube Material	Connection Part No.	Threads	Connection Material
54-4989	54-4987	1/4" i.d. x 3/8" o.d. x 25 ft.	100 psi	Polyurethane (red)	none	n/a	n/a
71-4800	54-4987	1/4" i.d. x 3/8" o.d. x 35 ft.	100 psi	Polyurethane (red)	none	n/a	n/a
71-4801	54-4987	1/4" i.d. x 3/8" o.d. x 50 ft.	100 psi	Polyurethane (red)	none	n/a	n/a
71-4803	54-4987	1/4" i.d. x 3/8" o.d. x 28 ft.	100 psi	Polyurethane (red)	none	n/a	n/a
71-4991	54-4987	1/4" i.d. x 3/8" o.d. x 25 ft.	100 psi	Polyurethane (red)	1 ea 54-4976 Tubing connector	1/4" nps(f)	Brass pltd
71-4804	54-4987	1/4" i.d. x 3/8" o.d. x 53 ft.	100 psi	Polyurethane (red)	none	n/a	n/a

### 1/8" I.D. Air Hose Assemblies (for Wren Airbrush)

Part Number	Bulk Hose No.	Size	Max. Working Pressure	Tube Material	Connection Part No.	Threads	Connection Material
59-61	71-113	1/8" i.d. x 5/16" o.d. x 6 ft.	250 psi	Rubber	72-93 x 59-50	1/4" nps(f) x 1/4"-40(f)	Brass pltd

### Breathable Air Hose Assemblies (For MPV Air Respirator)

Part Number	Bulk Hose No.	Size	Max. Working Pressure	Tube Material	Connection Part No.	Threads	Connection Material
MPV-457	n/a	(see note)	n/a	n/a	n/a	n/a	n/a
MPV-530	n/a	5/16" i.d. (see note)	250 psi	Rubber	n/a	male stem / QD	Steel pltd
MPV-550	n/a	5/16" i.d. (see note)	250 psi	Rubber	n/a	male stem / QD	Steel pltd

Note: These MPV hose assemblies are used with the MPV-625 Air Supplied Respirator only, and are NIOSH approved. Alternate hoses must not be substituted. Otherwise, NIOSH approval will be void, and an unsafe condition may result.

E.V.A. = Ethylene Vinyl Acetate    E.P.D.M. = Ethylene Propylene Diene Rubber    s.s. = Stainless steel  
 Steel pltd = Steel plated    Brass pltd = Brass plated    n/a = Not available

# Hose, Connections & Assemblies

## Fluid Hose Assemblies

### Fluidall™ Hose Assemblies (Low Pressure)

Part Number	Bulk Hose No.	Size	Max. Working Pressure	Tube Material	Connection Part No.	Threads	Connection Material
71-3260	71-280	1/4" i.d. x 1/2" o.d. x 5 ft.	500 psi	Nylon	72-1303	1/4" nps(f)	Brass pltd
71-3279	71-280	1/4" i.d. x 1/2" o.d. x 9"	500 psi	Nylon	72-1303	1/4" nps(f)	Brass pltd
71-3380	71-280	1/4" i.d. x 1/2" o.d. x 5 ft.	500 psi	Nylon	72-1306	3/8" nps(f)	Brass pltd
71-3383	71-280	1/4" i.d. x 1/2" o.d. x 25 ft.	500 psi	Nylon	72-1306	3/8" nps(f)	Brass pltd
71-3384	71-280	1/4" i.d. x 1/2" o.d. x 50 ft.	500 psi	Nylon	72-1306	3/8" nps(f)	Brass pltd
71-3390	71-280	1/4" i.d. x 1/2" o.d. x 35 ft.	500 psi	Nylon	72-1306	3/8" nps(f)	Brass pltd
71-3663	71-280	1/4" i.d. x 1/2" o.d. x 25 ft.	500 psi	Nylon	72-2143	3/8" nps(f)	s.s.
71-3300	71-282	3/8" i.d. x 11/16" o.d. x 5 ft.	500 psi	Nylon	72-1328	3/8" nps(f)	Brass pltd
71-3303	71-282	3/8" i.d. x 11/16" o.d. x 25 ft.	500 psi	Nylon	72-1328	3/8" nps(f)	Brass pltd
71-3304	71-282	3/8" i.d. x 11/16" o.d. x 50 ft.	500 psi	Nylon	72-1328	3/8" nps(f)	Brass pltd
71-3313	71-282	3/8" i.d. x 11/16" o.d. x 17"	500 psi	Nylon	72-1328	3/8" nps(f)	Brass pltd
71-3400	71-283	1/2" i.d. x 7/8" o.d. x 5 ft.	750 psi	Nylon	72-1334	1/2" nps(f)	Brass pltd
71-3403	71-283	1/2" i.d. x 7/8" o.d. x 25 ft.	750 psi	Nylon	72-1334	1/2" nps(f)	Brass pltd
71-3404	71-283	1/2" i.d. x 7/8" o.d. x 50 ft.	750 psi	Nylon	72-1334	1/2" nps(f)	Brass pltd
71-3361	71-285	1" i.d. x 1 1/2" o.d. x 10 ft.	750 psi	Nylon	72-1936	1" nps(f)	Brass pltd

E.V.A. = Ethylene Vinyl Acetate    E.P.D.M. = Ethylene Propylene Diene Rubber    s.s. = Stainless steel  
 Steel pltd = Steel plated    Brass pltd = Brass plated    n/a = Not available

# Hose, Connections & Assemblies

## Fluid Hose Assemblies

### Hose Assembly Sets (Air & Fluid)

Part Number	Bulk Hose No.	Size	Max. Working Pressure	Tube Material	Connection Part No.	Threads	Connection Material
6-438	71-11000	5/16" i.d. x 5/8" o.d. x 25 ft. (air) 71-1205	250 psi	Rubber	72-1317	1/4" nps(f) air	Brass pltd
	71-282	3/8" i.d. x 11/16" o.d. x 25 ft. (fluid) 71-3303	500 psi	Nylon	72-1328	3/8" nps(f) fluid	Brass pltd
KB-4006	71-11000	5/16" i.d. x 5/8" o.d. x 5 ft. 9 in. (air)	250 psi	Rubber	72-1317	1/4" nps(f) air	Brass pltd
	71-280	1/4" i.d. x 1/2" o.d. x 6 ft. 3 in. (fluid)	500 psi	Nylon	72-1306	3/8" nps(f) fluid	Brass pltd

### Siphon Fluid Hose Assemblies

Part Number	Bulk Hose No.	Size	Max. Working Pressure	Tube Material	Connection Part No.	Threads	Connection Material
41-11211	71-284	3/4" i.d. x 1-3/16" o.d. x 5 ft.	750 psi	Nylon	72-1935	3/4" nps(f)	Steel pltd
41-11216	71-284	3/4" i.d. x 1-3/16" o.d. x 8 ft.	750 psi	Nylon	72-1935	3/4" nps(f)	Steel pltd
41-11210	71-285	1" i.d. x 1-1/2" o.d. x 8 ft.	750 psi	Nylon	72-1936	1" nps(f)	Steel pltd
41-11212	71-285	1" i.d. x 1-1/2" o.d. x 5 ft.	750 psi	Nylon	72-1936	1" nps(f)	Steel pltd
44-1641	71-285	1" i.d. x 1-1/2" o.d. x 7 ft.	750 psi	Nylon	(2) 72-2329, 72-2330, 72-415	(2) 1" nps(f)	s.s.
103-1313	71-285	1" i.d. x 1 1/2" o.d. x 8 ft.	750 psi	Nylon	72-1936 plus 72-2334 spring guard	1" npt(f)	Steel pltd
103-1349	71-285	1" i.d. x 1 1/2" o.d. x 8 ft.	750 psi	Nylon	72-1936 plus 72-2334	1" npt(f) x 1" npt(f)	Steel pltd
103-1350	71-285	1" i.d. x 1 1/2" o.d. x 5 ft.	750 psi	Nylon	72-1936 plus 72-2334 spring guard	1" npt(f) x 1" npt(f)	Steel pltd
103-2029	71-285	1" i.d. x 1 1/2" o.d. x 8 ft.	750 psi	Nylon	72-1981	1" nps(m) x 1" npt(m)	Steel pltd

E.V.A. = Ethylene Vinyl Acetate    E.P.D.M. = Ethylene Propylene Diene Rubber    s.s. = Stainless steel  
 Steel pltd = Steel plated    Brass pltd = Brass plated    n/a = Not available

# Hose, Connections & Assemblies

## Fluid Hose Assemblies

### Nylon Tube Assemblies

Part Number	Bulk Hose No.	Size	Max. Working Pressure	Tube Material	Connection Part No.	Threads	Connection Material
71-7686	71-230	3/16" i.d. x .264 o.d. x 15 ft.	225 psi	Nylon	72-1792, 72-1793	1/4" nps(f) x 3/8" nps(f)	w/ Spring guards
71-7687	71-230	3/16" i.d. x .264 o.d. x 25 ft.	225 psi	Nylon	72-1793, 72-1792	1/4" nps(f) x 3/8" nps(f)	303 s.s.
71-7797	71-229	3/8" i.d. x 1/2" o.d. x 15 ft.	200 psi	Nylon	72-1812	3/8" nps(f)	s.s.
71-7778	71-229	3/8" i.d. x 1/2" o.d. x 25 ft.	200 psi	Nylon	72-1812	3/8" nps(f)	s.s.
71-7357	71-227	1/4" i.d. x .350" o.d. x 25 ft.	200 psi	Nylon	72-1802	3/8" nps(f)	s.s. w/ Spring guards

### Fluid Hose Drains (Low Pressure) (connection one end)

Part Number	Bulk Hose No.	Size	Max. Working Pressure	Tube Material	Connection Part No.	Threads	Connection Material
71-7328	71-227	1/4" i.d. x .350 o.d. x 23"	225 psi	Nylon	72-63, 72-93	1/4" nps(f)	Brass pltd
71-7332	71-227	1/4" i.d. x .350 o.d. x 3 ft.	225 psi	Nylon	72-63, 72-93	1/4" nps(f)	Brass pltd

### Contractor Quality Airless Paint Hose (Conductive – No Wire)

Part Number	Bulk Hose No.	Size	Max. Working Pressure	Tube Material	Connection Part No.	Threads	Connection Material
71-3530	n/a	1/4" i.d. x 25 ft.	3300 psi	Nylon	n/a	1/4" nps(f)	Steel pltd
71-3531	n/a	1/4" i.d. x 50 ft.	3300 psi	Nylon	n/a	1/4" nps(f)	Steel pltd

E.V.A. = Ethylene Vinyl Acetate    E.P.D.M. = Ethylene Propylene Diene Rubber    s.s. = Stainless steel  
 Steel pltd = Steel plated    Brass pltd = Brass plated    n/a = Not available

# Hose, Connections & Assemblies

## Fluid Hose Assemblies

### Premium Airless Paint Hose (Conductive – No Wire)

Part Number	Bulk Hose No.	Size	Max. Working Pressure	Tube Material	Connection Part No.	Threads	Connection Material
71-8085	n/a	3/16" i.d. x 5 ft.	3000 psi	Nylon	Permanent w/ spring guards	1/4" nps(f)	Steel pltd
71-8088	n/a	3/16" i.d. x 25 ft.	3000 psi	Nylon	Permanent w/ spring guards	1/4" nps(f)	Steel pltd
71-8089	n/a	3/16" i.d. x 50 ft.	3000 psi	Nylon	Permanent w/ spring guards	1/4" nps(f)	Steel pltd
71-7703	n/a	1/4" i.d. x 15 ft.	3000 psi	Nylon	Permanent w/ spring guards	1/4" nps(f)	Steel pltd
71-7704 (OBS – use 71-4830)	n/a	1/4" i.d. x 25 ft.	3000 psi	Nylon	Permanent w/ spring guards	1/4" nps(f)	Steel pltd
71-7705	n/a	1/4" i.d. x 50 ft.	3000 psi	Nylon	Permanent w/ spring guards	1/4" nps(f)	Steel pltd
71-7708	n/a	1/4" i.d. x 5 ft.	3000 psi	Nylon	Permanent w/ spring guards	1/4" nps(f)	Steel pltd
71-7709	n/a	1/4" i.d. x 10 ft.	3000 psi	Nylon	Permanent w/ spring guards	1/4" nps(f)	Steel pltd
71-7504	n/a	5/16" i.d. x 25 ft.	3000 psi	Nylon	Permanent w/ spring guards	1/4" nps(f)	Steel pltd
71-7505	n/a	5/16" i.d. x 50 ft.	3000 psi	Nylon	Permanent w/ spring guards	1/4" nps(f)	Steel pltd
71-7508	n/a	5/16" i.d. x 35 ft.	3000 psi	Nylon	Permanent w/ spring guards	1/4" nps(f)	Steel pltd
71-8421	n/a	3/8" i.d. x 5 ft.	3000 psi	Nylon	Permanent w/ spring guards	3/8" nps(f)	Steel pltd
71-8424	n/a	3/8" i.d. x 25 ft.	3000 psi	Nylon	Permanent w/ spring guards	3/8" nps(f)	Steel pltd
71-8425	n/a	3/8" i.d. x 50 ft.	3000 psi	Nylon	Permanent w/ spring guards	3/8" nps(f)	Steel pltd

E.V.A. = Ethylene Vinyl Acetate    E.P.D.M. = Ethylene Propylene Diene Rubber    s.s. = Stainless steel  
 Steel pltd = Steel plated    Brass pltd = Brass plated    n/a = Not available

# Hose, Connections & Assemblies

## Fluid Hose Assemblies

### PIT BULL™ Airless Paint Hose (Conductive)

Part Number	Bulk Hose No.	Size	Max. Working Pressure	Tube Material	Connection Type	Threads	Connection Material
71-4830	n/a	1/4" i.d. x 25 ft.	4000 psi	Nylon (Yellow)	Permanent w/ spring guards	1/4" nps(f)	Steel pltd
71-4831	n/a	1/4" i.d. x 50 ft.	4000 psi	Nylon (Yellow)	Permanent w/ spring guards	1/4" nps(f)	Steel pltd
71-4840	n/a	1/4" i.d. x 25 ft.	10,000 psi	Nylon (Yellow)	Permanent w/ spring guards	1/4" nps(f)	Steel pltd
71-4841	n/a	1/4" i.d. x 50 ft.	10,000 psi	Nylon (Yellow)	Permanent w/ spring guards	1/4" nps(f)	Steel pltd
71-4850	n/a	3/8" i.d. x 25 ft.	3500 psi	Nylon (Yellow)	Permanent w/ spring guards	3/8" nps(f)	Steel pltd
71-4851	n/a	3/8" i.d. x 50 ft.	3500 psi	Nylon (Yellow)	Permanent w/ spring guards	3/8" nps(f)	Steel pltd
71-4860	n/a	3/8" i.d. x 25 ft.	8000 psi	Nylon (Yellow)	Permanent w/ spring guards	3/8" nps(f)	Steel pltd
71-4861	n/a	3/8" i.d. x 50 ft.	8000 psi	Nylon (Yellow)	Permanent w/ spring guards	3/8" nps(f)	Steel pltd

### PIT BULL™ Whip-End Fluid Hose Assemblies

Part Number	Bulk Hose No.	Size	Max. Working Pressure	Tube Material	Connection Type	Threads	Connection Material
71-4870	n/a	1/4" i.d. x 3 ft.	10,000 psi	Nylon (Yellow)	Permanent w/ spring guards	3/8" nps(m) x 1/4" nps(f)	Steel pltd
71-4871	n/a	1/4" i.d. x 3 ft.	10,000 psi	Nylon (Yellow)	Permanent w/ spring guards	1/4" nps(m) x 1/4" nps(f)	Steel pltd
71-4872	n/a	1/4" i.d. x 3 ft.	10,000 psi	Nylon (Yellow)	Permanent w/ spring guards	3/8" nps(m) x 1/4" nps(f)	Steel pltd

### Whip-End Fluid Hose Assemblies

Part Number	Bulk Hose No.	Size	Max. Working Pressure	Tube Material	Connection Type	Threads	Connection Material
71-8360	n/a	3/16" i.d. x 30"	3000 psi	Nylon	Permanent w/ spring guards	1/4" nps(f) x 1/4" nps(m)	Steel pltd
71-6844	n/a	1/8" i.d. x 3 ft.	5000 psi	Nylon	Permanent w/ spring guards	1/4" nps(f) x 1/4" nps(m)	Steel pltd
71-6845	n/a	1/8" i.d. x 5 ft.	5000 psi	Nylon	Permanent w/ spring guards	1/4" nps(f) x 1/4" nps(m)	Steel pltd

E.V.A. = Ethylene Vinyl Acetate    E.P.D.M. = Ethylene Propylene Diene Rubber    s.s. = Stainless steel  
 Steel pltd = Steel plated    Brass pltd = Brass plated    n/a = Not available

# Hose, Connections & Assemblies

## Fluid Hose Assemblies

### Air-assist Airless Fluid Hose Assemblies

Part Number	Bulk Hose No.	Size	Max. Working Pressure	Tube Material	Connection Type	Threads	Connection Material
71-4992	n/a	1/8" i.d. x 15 ft.	4000 psi	Nylon (Yellow)	Permanent w/o spring guards	1/4" npt(f)	s.s.
71-4993	n/a	1/8" i.d. x 25 ft.	5000 psi	Nylon (Yellow)	Permanent w/o spring guards	1/4" nps(f)	s.s.
71-4995	n/a	3/16" i.d. x 25 ft.	1900 psi	Nylon (Blue)	Permanent w/o spring guards	1/4" nps(f)	s.s.

### Air Hose Assemblies (Low Pressure – FRP)

Part Number	Bulk Hose No.	Size	Max. Working Pressure	Tube Material	Connection Part No.	Threads	Connection Material
207-11512-3	71-227	1/4" i.d. x .350 o.d. x 25 ft.	225 psi	Nylon	72-1687	1/4" nps(f)	Brass pltd
207-11512-8	71-227	1/4" i.d. x .350 o.d. x 50 ft.	225 psi	Nylon	72-1687	1/4" nps(f)	Brass pltd
207-10770-8	71-11000	5/16" i.d. x 5/8" o.d. x 50 ft.	250 psi	EPDM	72-1317	1/4" nps(f)	Brass pltd

### Fluid Hose Assemblies (Low Pressure)

Part Number	Bulk Hose No.	Size	Max. Working Pressure	Tube Material	Connection Part No.	Threads	Connection Material
207-10941-8	4282	1/2" i.d. x 30"	2000 psi	Nylon	n/a	3/4" - 16 J.I.C. sw.	Steel pltd
207-12269-2	71-283	1/2" i.d. x 7/8" o.d.	750 psi	Nylon	n/a	3/4" - 16 J.I.C. sw.	Steel pltd
207-12269-5	71-283	1/2" i.d. x 7/8" o.d.	750 psi	Nylon	n/a	3/4" - 16 J.I.C. sw.	Steel pltd

E.V.A. = Ethylene Vinyl Acetate    E.P.D.M. = Ethylene Propylene Diene Rubber    s.s. = Stainless steel  
 Steel pltd = Steel plated    Brass pltd = Brass plated    n/a = Not available

# Hose, Connections & Assemblies

## FRP Hose Assemblies

### Misc. Air/Fluid Hose Assemblies (FRP)

Part Number	Bulk Hose No.	Size	Max. Working Pressure	Tube Material	Connection Part No.	Threads	Connection Material	Type
207-10910-6	n/a	1/2" i.d. x 13/16" o.d. x 18"	200 psi	n/a	n/a	1/2" npt(m)	Brass pltd	Air
207-11016-2	71-280	1/4" i.d. x 20"	500 psi	Nylon	KF04-04RV x KF04-04PS	1/4" nps(f) x 1/4" npt(m)	Brass pltd	Air/fluid

### 1/4" I.D. Fluid Hose Assemblies (High Pressure Airless, Wireless)

Part Number	Bulk Hose No.	Size	Max. Working Pressure	Tube Material	Connection Part No.	Threads	Connection Material
207-10769-1	n/a	1/4" i.d. x 5 ft.	3000 psi	Nylon	Permanent	9/16" - 18 J.I.C. sw.	n/a
207-10769-11	n/a	1/4" i.d. x 9 1/2"	3000 psi	Nylon	Permanent	9/16" - 18 J.I.C. sw.	n/a
207-10769-5	n/a	1/4" i.d. x 35 ft.	3000 psi	Nylon	Permanent	9/16" - 18 J.I.C. sw.	n/a



# Hose, Connections & Assemblies

## Catalyst Hose Assemblies (FRP)

### Recommended Use

For acid and peroxidized catalyst and other aqueous (water) solutions. Also recommended for use as a light weight, low pressure air hose. May be used for buffing compounds and concrete resurfacing materials.

### Tube

EVA

### Reinforcement

Single open braid, reyon/nylon

### Cover

EVA – blue

### Connections

Reuseable, stainless steel tailpiece and swivel, aluminum nut.

SIZES AVAILABLE		BULK HOSE NO.	MAXIMUM WORKING PRESSURE (psi)	NO. OF BRAIDS	APPROX. SHIPPING WEIGHT BASED ON FEET PER REEL	HOSE WEIGHT PER 100 FEET	CONNECTION	
i.d.	o.d.						THREAD	PART NO.
1/8	5/16	71-201	100	1	16	3.2	1/4"nps(f)	102-3031 SS316 ●
5/16	17/32	71-508	250	1	33.5	6.7	1/4"nps(f) 3/8"nps(f)	72-1646 SS416 ● 207-10383 SS416 ●
3/8	19/32	71-509	250	1	37.5	7.5	3/8"nps(f)	102-3040 s.s. 316

● These assemblies have connections with spring guards

## Catalyst Hose Assemblies (Low Pressure)

Part Number	Bulk Hose No.	Size	Max. Working Pressure	Tube Material	Connection Part No.	Threads	Connection Material
102-3028	71-201	1/8" i.d. x 5/16" o.d. x 25 ft.	100 psi	E.V.A. (Blue)	102-3031	1/4" nps(f) sw.	316 s.s.
102-3029	71-201	1/8" i.d. x 5/16" o.d. x 35 ft.	100 psi	E.V.A. (Blue)	102-3031	1/4" nps(f) sw.	316 s.s.
102-3030	71-201	1/8" i.d. x 5/16" o.d. x 50 ft.	100 psi	E.V.A. (Blue)	102-3031	1/4" nps(f) sw.	316 s.s.
102-3034	71-201	1/8" i.d. x 5/16" o.d. x 30"	100 psi	E.V.A. (Blue)	n/a	1/4" nps(f) sw.	316 s.s.
102-3036	71-201	1/8" i.d. x 5/16" o.d. x 3 ft.	100 psi	E.V.A. (Blue)	n/a	1/4" nps(f) sw.	316 s.s.
102-3035	71-509	3/8" i.d. x 19/32" o.d. x 3 ft.	250 psi	E.V.A. (Blue)	72-1367, 102-3033	3/8" nps(f) sw.	316 s.s.
71-2732	71-508	5/16" i.d. x 33/64" o.d. x 15 ft.	250 psi	E.V.A. (Blue)	72-1646	1/4" nps(f) sw.	416 s.s.
71-2734	71-508	5/16" i.d. x 33/64" o.d. x 25 ft.	250 psi	E.V.A. (Blue)	72-1646	1/4" nps(f) sw.	416 s.s.
71-2735	71-508	5/16" i.d. x 33/64" o.d. x 50 ft.	250 psi	E.V.A. (Blue)	72-1646	1/4" nps(f) sw.	416 s.s.

E.V.A. = Ethylene Vinyl Acetate    E.P.D.M. = Ethylene Propylene Diene Rubber    s.s. = Stainless steel  
Steel pltd = Steel plated    Brass pltd = Brass plated    n/a = Not available

# Hose, Connections & Assemblies

## Catalyst Hose Assemblies (FRP)

### 3/16" I.D. Fluid Hose Assemblies (High Pressure Catalyst)

Part Number	Bulk Hose No.	Size	Max. Working Pressure	Tube Material	Connection Part No.	Threads	Connection Material
207-12305-3	n/a	3/16" i.d. x 5/16" o.d. x 38"	3000 psi	PTFE/ s.s. braided	Permanent	7/16"-20 J.I.C. sw. J.I.C. #4	s.s.
207-12305-4	n/a	3/16" i.d. x 5/16" o.d. x 25 ft.	3000 psi	PTFE/ s.s. braided	Permanent	7/16"-20 J.I.C. sw. J.I.C. #4	s.s.
207-12305-6	n/a	3/16" i.d. x 5/16" o.d. x 50 ft.	3000 psi	PTFE/ s.s. braided	Permanent	7/16"-20 J.I.C. sw. J.I.C. #4	s.s.
207-12305-7	n/a	3/16" i.d. x 5/16" o.d. x 35 ft.	3000 psi	PTFE/ s.s. braided	Permanent	7/16"-20 J.I.C. sw. J.I.C. #4	s.s.
207-12305-9	n/a	3/16" i.d. x 5/16" o.d. x 17"	3000 psi	PTFE/ s.s. braided	Permanent	7/16"-20 J.I.C. sw. J.I.C. #4	s.s.

## Fittings

<b>ADAPTERS</b>	<b>6-2</b>
<b>SWIVEL CONNECTIONS</b>	<b>6-2</b>
<b>SWIVEL ADAPTERS</b>	<b>6-3</b>
<b>SWIVEL UNIONS</b>	<b>6-3</b>
<b>REDUCING BUSHINGS</b>	<b>6-4</b>
<b>NIPPLES &amp; REDUCING NIPPLES</b>	<b>6-4</b>
<b>ELBOWS</b>	<b>6-7</b>
<b>MISC. CONNECTIONS</b>	<b>6-8</b>
<b>TEES &amp; CROSSES</b>	<b>6-8</b>
<b>PIPE PLUGS</b>	<b>6-9</b>
<b>QUICK DISCONNECTS</b>	<b>6-10</b>
<b>GUN / OUTLET MANIFOLDS</b>	<b>6-12</b>

# Fittings

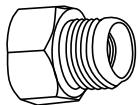

72-54, P-H-4105

## Adapters

Part Number	Description	Materials	Max. Working Pressure	Inlet	Outlet
<b>LOW PRESSURE</b>					
72-54	Adapter	Brass pltd	250 psi	1/4" nps(f)	3/8" nps(m)
P-H-4105	Adapter	Brass pltd	250 psi	1/4" nps(f)	3/8" nps(m)
73-131	Adapter	Brass pltd	250 psi	1/4" nps(m)	1/4" nps(f)
72-55	Adapter	Brass pltd	250 psi	1/4" nps(m)	3/8" nps(f)
73-130	Adapter	Brass pltd	250 psi	3/8" nps(m)	3/8" nps(f)
0115-010235	Adapter	s.s.	250 psi	3/4" nps(m)	1/2" nps(f)
<b>HIGH PRESSURE</b>					
207-10699	Adapter	303 s.s.	3500 psi	1/4" nps(m)	1/4" npt(f)
72-727	Adapter	303 s.s.	4000 psi	1/8" npt(f)	1/4" nps(m)
72-731	Adapter	Steel pltd	5000 psi	3/8" npt(f)	1/4" nps(m)
102-2193*	Adapter	303 s.s.	7500 psi	3/8" npt(f)	1/4" nps(m)

\*Requires 54-1439 gasket (order separately)



73-18

## Swivel Connections (90°)

Part Number	Description	Materials	Max. Working Pressure	Inlet	Outlet
<b>LOW PRESSURE</b>					
SSP-30-ZN	90° swivel	Steel pltd	250 psi	1/4" npt(m)	1/4" nps(f)
72-989	Swivel ass'y 90 deg. 5, 10 & 15 Gal tanks, single tank outlet	Brass pltd	250 psi	3/8" npt(f)	7/8-18 (f)
73-16	Swivel connection	Brass pltd	250 psi	3/8" nps(f)	3/8" nps(m)
73-18	Elbow swivel 90 deg.	Brass pltd	250 psi	1/4" nps(m)	3/8" nps(f)
<b>HIGH PRESSURE</b>					
72-918	Connection 90 deg.	Steel	4000 psi	1/4" npt(f)	1/4" nps(f)
73-24	Elbow swivel 90 deg.	303 s.s.	3000 psi	3/8" nps(m)	3/8" nps(f)
SSP-57-ZN	90° Swivel connection	Steel pltd	4000 psi	3/8" npt(m)	3/8" nps(f)
207-12085	Reducing Elbow	s.s.	6000 psi	1/2" nps(f) sw	#4 J.I.C.(m)
<b>DOUBLE OUTLET</b>					
72-994	Double tank outlet, 60 gal tank	Brass pltd	200 psi	7/8-18" nps(f)	(2) 3/8" npt(f)

N/R = Non-Rated • Pltd brass = Plated brass, chrome • S.S. = Stainless steel  
Galv. = Galvanized steel • Steel pltd = Plated steel, cadmium or zinc • Poly = Polypropylene plastic

# Fittings



SSP-8217-ZN

## Swivel Adapters (Straight)

Part Number	Description	Materials	Max. Working Pressure	Inlet	Outlet
SSP-8217-ZN	Swivel adapter	Steel pltd	4000 psi	1/4" nps(f)	1/4" npt(m)
103-1238	Swivel adapter	s.s.	4000 psi	1/4" npt(m)	3/8" nps(f)
20-4281	Swivel adapter	Steel pltd	4000 psi	3/8" npt(m)	3/8" nps(f)
20-4284	Swivel adapter	Steel pltd	3000 psi	3/4" npt(m)	3/4" nps(f)
20-4283	Swivel adapter	Steel pltd	3500 psi	1/2" npt(m)	1/2" nps(f)
PLH-6SN-6TSS	Swivel adapter	s.s.	250 psi	3/8" nps(m)	3/8" nps(f)
0114-016058	Swivel adapter	s.s.	7250 psi	1/4" bspt(m)	3/8" BPS(f)
0115-010324	Swivel adapter	Steel pltd	5000 psi	3/8" -19 bspt(m)	3/8" -19 bspp(f)

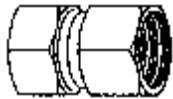

83-1935, 102-2126

## Swivel Unions

Part Number	Description	Materials	Max. Working Pressure	Inlet	Outlet
72-1253	Swivel union	Steel pltd	4000 psi	3/8" npt(f)	1/4" nps(f)
83-1935	Swivel union	Steel pltd	4000 psi	1/4" npt(f)	1/4" nps(f)

N/R = Non-Rated • Pltd brass = Plated brass, chrome • S.S. = Stainless steel  
Galv. = Galvanized steel • Steel pltd = Plated steel, cadmium or zinc • Poly = Polypropylene plastic

# Fittings



20-3809-1

## Reducing Bushings

Part Number	Description	Materials	Max. Working Pressure	Male	Female
<b>LOW PRESSURE</b>					
20-2525	Bushing	Galv.	250 psi	3/4" npt(m)	1/2" npt(f)
<b>HIGH PRESSURE</b>					
20-3809-1	Bushing	Steel pltd	4000 psi	1/2" npt(m)	1/4" npt(f)
20-3815	Bushing	304 s.s.	3000 psi	1/2" npt(m)	3/8" npt(f)
20-3823-1	Bushing	Steel pltd	3000 psi	1/2" npt(m)	3/8" npt(f)
20-4924	Bushing	Steel pltd	3000 psi	1-1/4" npt(m)	1" npt(f)
237-614	Bushing	Steel	4000 psi	1" npt(m)	3/4" npt(m)
20-4347	Bushing	Steel pltd	3000 psi	3/4" npt(m)	3/8" npt(f)
20-1753-1	Bushing	Steel pltd	4000 psi	3/8" npt(m)	1/4" npt(f)
20-3083	Bushing	316 s.s.	4000 psi	3/8" npt(m)	1/4" npt(f)



H-2008



AD-26



83-576

## Nipples & Reducing Nipples

Part Number	Description	Materials	Max. Working Pressure	Inlet	Outlet
<b>LOW PRESSURE</b>					
54-308	Reducing nipple	Brass pltd	250 psi	1/8" nps(m)	1/4" nps(m)
71-28	Reducing nipple	Brass pltd	750 psi	1/8" npt(m)	1/4" nps(m)
H-2008	Nipple	Brass pltd	750 psi	1/4" nps(m)	1/4" npt(m)
83-1050	D.M. Nipple	Brass	750 psi	1/4" nps(m)	1/4" nps(m)
AD-31	D.M. Nipple	Brass pltd	750 psi	1/4" nps(m)	1/4" nps(m)
AD-26	Reducing nipple	Brass pltd	750 psi	1/4" nps(m)	3/8" npt(m)
SSP-462-ZN	D.M. Nipple	Steel pltd	750 psi	1/4" npt(m)	1/4" npt(m)
57-13-1	D.M. Nipple	Brass pltd	750 psi	1/4" npt(m)	1/4" nps(m)/bspp(m)
83-576	D.M. Nipple	Brass	750 psi	1/4" npt(m)	1/4" nps(m)
H-209	D.M. Nipple	Brass pltd	750 psi	1/4" npt(m)	9/16-20 (m)
0115-010333	D.M. Nipple	Brass pltd	260 psi	3/8" bspp(m)	3/8" bspp(m)

N/R = Non-Rated • Pltd brass = Plated brass, chrome • S.S. = Stainless steel  
Galv. = Galvanized steel • Steel pltd = Plated steel, cadmium or zinc • Poly = Polypropylene plastic

# Fittings



H-2008



AD-26



83-576

## Nipples & Reducing Nipples

Part Number	Description	Materials	Max. Working Pressure	Inlet	Outlet
<b>LOW PRESSURE (continued)</b>					
83-1294	D.M. Nipple	Brass pltd	750 psi	3/8" nps(m)	3/8" nps(m)
PLH-6-6TSS	Nipple	300 s.s.	250 psi	3/8" npt(m)	3/8" nps(m)
AD-11	D.M. Nipple	Brass pltd	750 psi	3/8" npt(m)	3/8" nps(m)
73-50	D.M. Nipple	Brass pltd	750 psi	3/8" npt(m)	3/8" nps(m)
83-1185	D.M. Nipple	Brass pltd	750 psi	3/8" npt(m)	3/8" npt(m)
83-1823	D.M. Nipple	Brass	500 psi	1/2" npt(m)	1/2" nps(m)
72-1243	D.M. Nipple	Brass pltd	500 psi	1/2" npt(m)	1/2" nps(m)
83-1822	D.M. Nipple	Brass pltd	750 psi	3/4" nps(m)	3/4" nps(m)
72-423	D.M. Nipple	Brass pltd	500 psi	1" npt(m)	1" nps(m)
72-2344	Nipple	Steel pltd	750 psi	1" npt(m)	1-1/2" nps(m)
<b>HIGH PRESSURE</b>					
237-859	D.M. Nipple	316 s.s.	6000 psi	#3 J.I.C. (m)	#3 J.I.C. (m)
237-871	D.M. Nipple	316 s.s.	5000 psi	#4 J.I.C. (m)	#4 J.I.C. (m)
107-1439	D.M. Nipple	316 s.s.	5000 psi	#4 J.I.C. (m)	1/4" npt(m)
107-1449	Reducing nipple	s.s.	5000 psi	#4 J.I.C. (m)	1/8" npt(m)
207-12349	Reducing nipple	303 s.s.	4000 psi	#4 J.I.C. (m)	3/8-24 unf (m)
72-792	Reducing nipple	303 s.s.	7500 psi	1/8" npt(m)	1/4" nps(m)
72-969	Reducing nipple	303 s.s.	3000 psi	1/8" npt(m)	3/8" nps(m)
HGS-22	Reducing nipple	s.s.	3000 psi	1/8" npt(m)	1/4" nps(m)
HGS-21	Reducing nipple	s.s.	3000 psi	1/8" npt(m)	3/8" nps(m)
72-1268	Reducing nipple	Steel pltd	5000 psi	1/4" npt(m)	3/8" npt(m)
72-790	D.M. Nipple	316 s.s.	4500 psi	1/4" npt(m)	1/4" nps(m)
20-4854	D.M. Nipple	316 s.s.	6000 psi	1/4" npt(m)	1/4" npt(m)
83-2484	Reducing nipple	303 s.s.	3000 psi	1/4" npt(m)	3/8" nps(m)
237-375	Nipple	Steel pltd	6000 psi	1/4" npt / nps(m)	1/4" npt / nps(m)
83-4233	Reducing nipple	Steel pltd	6000 psi	1/4" npt / nps(m)	3/8" npt / nps(m)
H-1580-H	Reducing nipple	s.s.	3000 psi	1/4" npt(m)	3/8" nps(m) / bsp (m)
72-791	D.M. Nipple	303 s.s.	4500 psi	1/4" nps(m)	1/4" nps(m)
72-691	D.M. Nipple	Steel pltd	6000 psi	1/4" nps(m)	1/4" nps(m)
0114-016059	Reducing nipple	s.s.	3000 psi	1/4" npt(m)	1/4" nps(m)
0114-019090	Reducing nipple	s.s.	3000 psi	1/4" bspt(m)	1/4" bspt(m)

N/R = Non-Rated • Pltd brass = Plated brass, chrome • S.S. = Stainless steel  
Galv. = Galvanized steel • Steel pltd = Plated steel, cadmium or zinc • Poly = Polypropylene plastic

# Fittings

**72-1888**

**83-2055**

**72-1316**

**873188**

## Nipples & Reducing Nipples

Part Number	Description	Materials	Max. Working Pressure	Inlet	Outlet
<b>HIGH PRESSURE (continued)</b>					
84-509	Nipple	303 s.s.	3000 psi	1/4" nps(m)	1/16" npt(m)
72-2322	Nipple	303 s.s.	3000 psi	1/4" npt/nps(m)	5/8"-24 UNEF-2A
101-1772	Reducing nipple	316 s.s.	5000 psi	1/4" nps(m)	1/8" npt(m)
72-1888	Reducing nipple	Steel pltd	6000 psi	1/4" nps(m)	3/8" nps(m)
72-988	Reducing nipple	303 s.s.	4500 psi	1/4" nps(m)	3/8" npt(m)
72-798	D.M. Nipple	303 s.s.	4500 psi	3/8" nps(m)	3/8" nps(m)
72-1933	Reducing nipple	303 s.s.	5000 psi	3/8" npt(m)	1/2" nps(m)
83-2055	D.M. Nipple	303 s.s.	4500 psi	3/8" npt(m)	3/8" nps(m)
72-998	D.M. Nipple	Steel pltd	3000 psi	3/8" npt(m)	3/8" npt(m)
SSP-459	D.M. Nipple	316 s.s.	6000 psi	3/8" npt(m)	3/8" npt(m)
237-266	D.M. Nipple	Steel	6000 psi	1/2" npt(m)	1/2" npt(m)
237-374	Reducing nipple	Steel	6000 psi	1/2" npt(m) / nps(m)	3/8" npt(m) / nps(m)
72-1316	Reducing nipple	Steel pltd	4000 psi	1/2" npt(m)	3/4" npt(m)
41-1235	D.M. Nipple	303 s.s.	2500 psi	1/2" nps(m)	1/2" npt(m)
72-1770	D.M. Nipple	303 s.s.	2000 psi	3/4" npt(m)	3/4" nps(m)
72-1102	D.M. Nipple	Steel pltd	4000 psi	3/4" npt(m)	3/4" npt(m)
101-713	D.M. Nipple	Steel, 3 1/2" long	5000 psi	3/4" npt(m)	3/4" nps(m)
41-28090	Reducing nipple	Steel pltd	6000 psi	3/4" npt(m)	1/2" npt(m)
72-1981	D.M. Nipple	Steel pltd	3500 psi	1" npt(m)	1" nps(m)
873188	Reducing nipple	Steel pltd	6000 psi	1" npt(m)	1/2" npt(m)

N/R = Non-Rated • Pltd brass = Plated brass, chrome • S.S. = Stainless steel  
Galv. = Galvanized steel • Steel pltd = Plated steel, cadmium or zinc • Poly = Polypropylene plastic



# Fittings

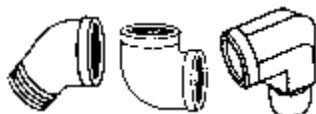

## Elbows

Part Number	Description	Materials	Max. Working Pressure	Inlet	Outlet
<b>LOW PRESSURE</b>					
20-11	Street elbow 90 deg.	Galv.	150 psi	1"	1"
20-100	Elbow street 90 deg.	Galv.	150 psi	1" npt(f)	1" npt(m)
20-6926	Street elbow 90 deg.	Polypropylene	150 psi	1/2"	1/2"
20-3780	Street elbow	s.s.	150 psi	1/2"	1/2"
20-3340-1	Elbow street 90 deg.	Brass pltd	250 psi	1/2" npt(m)	1/2" npt(f)
86-563	Elbow street 90 deg.	Brass pltd	250 psi	1/4" npt(m)	1/4" npt(f)
20-3645	Elbow street 90 deg.	Brass pltd	250 psi	1/8" npt(m)	1/8" npt(f)
237-572	Elbow 45 deg.	Brass	250 psi	1/8" npt(m)	#5 J.I.C. (m)
237-247	Elbow 90 deg.	Brass	250 psi	1/8" npt(m)	1/4" hose
20-6905	Reducing elbow 90 deg.	Steel pltd	250 psi	1-1/2" npt(m)	1" npt(m)
<b>HIGH PRESSURE</b>					
20-3590	Elbow street 90 deg.	s.s.	3000 psi	3/4" npt(m)	3/4" npt(f)
237-276	Reducing elbow 90 deg.	Steel pltd	6000 psi	1/2" npt(f)	#6 J.I.C. (m)
20-3821	Elbow street 90 deg.	Steel pltd	3000 psi	3/8" npt(m)	3/8" npt(f)
20-2848	Elbow 90 deg.	304 s.s.	4000 psi	1/4" npt(f)	1/4" npt(f)
101-1770	Elbow street 90 deg.	316 s.s.	7200 psi	1/4" npt(m)	1/4" npt(f)
107-1646	Elbow 90 deg.	316 s.s.	5000 psi	1/8" npt(m)	#4 J.I.C. (m)
237-767	Elbow street 45 deg.	Steel	5000 psi	1/4" npt(m)	1/4" npt(f)
207-12085	Reducing elbow 90 deg.	s.s.	6000 psi	#4 J.I.C. (m)	1/2" nps(f) sw.
SSP-1941-ZN	Street elbow 90 deg.	Steel pltd	5000 psi	1/4" npt(m)	1/4" npt(f)

N/R = Non-Rated • Pltd brass = Plated brass, chrome • S.S. = Stainless steel  
Galv. = Galvanized steel • Steel pltd = Plated steel, cadmium or zinc • Poly = Polypropylene plastic

# Fittings

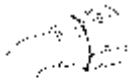

P-H-431, P-H-432

## Misc. Connections

Part Number	Description	Materials	Max. Working Pressure	Inlet	Outlet
<b>LOW PRESSURE</b>					
P-H-432	Fitting	n/a	750 psi	3/8" nps(f) sw	3/8" nps(m)
P-H-431	Fitting	n/a	750 psi	1/4" nps(f) sw	1/4" nps(m)
SSP-6102-K5	Fitting, 90 deg. Barbed	Brass	250 psi	1/8" npt(m)	.170 i.d. tube
4358	Fitting	n/a	750 psi	#12 J.I.C. (f) sw	3/4 i.d. hose

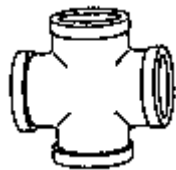

20-4593



101-2050

## Tees & Crosses

Part Number	Description	Type	Max. Working Pressure	Inlet	Outlet
20-4593	Cross	Steel	3000 psi	1/2" npt(f) all ports	1/2" npt(f) all ports
237-280	male run tee	Steel pltd	3000 psi	1/2" npt(m)	(2) 1/2" npt(f)
101-2050	Tee	316 s.s.	3000 psi	1/4" npt(f) all ports	1/4" npt(f) all ports
SSP-2629-ZN	Branch tee	Steel pltd	5000 psi	1/4" npt(m)	(2) 1/4" npt(f)
20-6788	Cross	Steel pltd	3000 psi	3/4" npt(f) all ports	3/4" npt(f) all ports

N/R = Non-Rated • Pltd brass = Plated brass, chrome • S.S. = Stainless steel  
Galv. = Galvanized steel • Steel pltd = Plated steel, cadmium or zinc • Poly = Polypropylene plastic

# Fittings



HEX



SQUARE  
HEAD

## Pipe Plugs – Internal Hex & Square Head

Part Number	Description	Materials	Max. Working Pressure	Inlet	Type
<b>HIGH PRESSURE</b>					
20-5692	Pipe plug	Steel pltd	4000 psi	1/16" npt(m)	Hex
20-5051	Pipe plug	s.s.	4000 psi	1/16" npt(m)	Hex
20-3111	Pipe plug	303 s.s.	4000 psi	1/8" npt(m)	Hex
20-2287-1	Pipe plug	Steel pltd	4000 psi	1/8" npt(m)	Hex
20-6131	Pipe plug	s.s.	4000 psi	1/4" npt(m)	Hex
20-2288-1	Pipe plug	Steel pltd	4000 psi	1/4" npt(m)	Hex
20-4401	Pipe plug	303 s.s.	4000 psi	1/4" npt(m)	Square head
86-558	Pipe plug	Steel pltd	4000 psi	1/4" npt(m)	Square head
237-338	Pipe plug	Steel pltd	4000 psi	1/4" npt(m)	Hex
20-1592	Pipe plug	Steel pltd	4000 psi	3/8" npt(m)	Square head
20-2097	Pipe plug	Steel	4000 psi	1/2" npt(m)	Hex
<b>NON-RATED</b>					
237-879	Pipe plug	Steel	n/r	2" npt(m)	Bung
20-2605-1	Pipe plug	Steel	n/r	3/8" npt(m)	Hex

N/R = Non-Rated • Pltd brass = Plated brass, chrome • S.S. = Stainless steel  
Galv. = Galvanized steel • Steel pltd = Plated steel, cadmium or zinc • Poly = Polypropylene plastic

# Fittings



P-HC-4808-1



72-1804

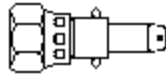

72-364

## Quick Disconnects – Bayonett Style (Fluid)

### Binks Style

Part Number	Type	Description	Max. Working Pressure	Connection	Service Form	Kit
72-1804	Body (f)	Stainless steel	500 psi	3/8" nps(m)	n/a	
72-364	Stem (m)	Stainless steel	500 psi	3/8" nps(f)	n/a	

### DeVilbiss Style

P-HC-4808-1	Body (f)	Aluminum	500 psi	3/8" nps(m)	SB-12-001	KK-5061
P-HC-4482	Stem (m)	Hardened Steel	500 psi	3/8" nps(f)	SB-12-001	
HC-513-1	Body (f)	Stainless steel	500 psi	3/8" nps(m)	SB-12-001	KK-5061
ODL-4808	Body (f)	Delrin/Stainless	500 psi	3/8" nps(m)	SB-12-001	KK-5061
HC-4691	Stem (m)	Stainless steel	500 psi	3/8" nps(f) swivel	SB-12-001	



72-885 w/72-887 stem connected

## Binks Quick Disconnects (Fluid – Solvent Based)

Part Number	Type	Description	Max. Working Pressure	Connection Size	Service Form
72-885	Body (f)	Steel	250 psi	3/8" nps(m)	77-1759
72-887*	Stem (m)	Steel	250 psi	3/8" nps(f)	77-1759

\*Replacement o-ring for stem: 20-3620-5 (5-pack Viton)

## Binks Quick Disconnect Assemblies (Fluid – Solvent Based)

Part Number	Description	Max. Working Pressure	Service Form
72-888	72-885 Body 72-887 Stem*	250 psi	77-1759

\*\*Replacement o-ring for stem: 20-3620-5 (5-pack Viton)



72-780

## Binks High Pressure Swivel Connection (Fluid – Solvent Based)

Part Number	Description	Materials	Max. Working Pressure	Inlet	Outlet
72-780	Swivel connection	Steel	3000 psi	1/4" nps(m)	1/4" nps(f)
72-2332	Swivel connection	Steel	7500 psi	1/4" nps(m)	1/4" nps(f)
72-2333	Swivel connection	Steel	7500 psi	3/8" nps(m)	1/4" nps(f)

N/R = Non-Rated • Pltd brass = Plated brass, chrome • S.S. = Stainless steel  
Galv. = Galvanized steel • Steel pltd = Plated steel, cadmium or zinc • Poly = Polypropylene plastic

# Fittings



72-2063



72-2066



72-2073



72-445



72-467

## Binks Quick Disconnects (Air)

Part Number	Type	Description	Connection Size	Max. Working Pressure	Service Form
72-2063	Body (f)	Standard	1/4" nps(m)	200 psi	n/a
72-2066	Body (f)	Standard	5/16 i.d. hose	200 psi	n/a
72-2073	Body (f)	Standard	1/4" npt(f)	200 psi	n/a
72-445	Stem (m)	Standard	1/4" nps(f)	200 psi	n/a
72-467	Stem (m)	Standard	1/4" npt(m)	200 psi	n/a

N/R = Non-Rated • Pltd brass = Plated brass, chrome • S.S. = Stainless steel  
Galv. = Galvanized steel • Steel pltd = Plated steel, cadmium or zinc • Poly = Polypropylene plastic

# Fittings



## DeVilbiss Quick Disconnects (Air)

Part Number	Type	Description	Connection Size	Max. Working Pressure	Service Form
P-H-4069	Stem	Air bayonet	1/4" npt(m)	250 psi	n/a
P-H-4090	Body	Air bayonet	1/4" npt(f)	250 psi	n/a
P-H-4091	Body	Air bayonet	1/4" npt(m)	250 psi	n/a



## DeVilbiss Quick Disconnects (High-Flow Air)

Part Number	Type	Description	Connection Size	Max. Working Pressure	Service Form
HC-4719	Body (f)	Hi-flow	1/4" universal (m)	230 psi	SB-12-001
HC-4720	Body (f)	Hi-flow	1/4" npt(f)	230 psi	SB-12-001
HC-1166	Stem (m)	Hi-flow	1/4" npt(m)	230 psi	SB-12-001
HC-4419	Stem (m)	Hi-flow	1/4" nps(f)	230 psi	SB-12-001
MPV-60-K3	Stem (f)	Hi-flow (ball swivel)	1/4" nps(f)	230 psi	n/a

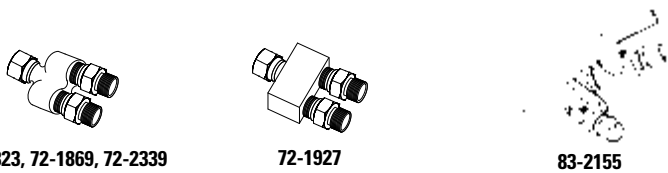

## Gun/Outlet Manifolds

Part Number	Max. Working Pressure	No. of Outlets	Outlet Threads	Inlet Swivel Nut	Notes
72-994	200 psi	2	3/8" npt(f)	7/8"-18 nps(f)	Pltd brass
72-1823	250 psi	2	3/8" nps(m)	3/8" nps(f)	Stainless steel
72-1869	1000 psi	2	1/4" nps(m)	3/8" nps(f)	Stainless steel
72-1927	2000 psi	2	1/4" nps(m)	1/4" nps(f)	H.P. steel fittings, plated steel body and swivel nut
83-2155	4000 psi	2	3/8" npt(m)	1" npt(f)	303 Stainless steel body with 4000 psi valves
72-2339	7250 psi	2	1/4" nps(m)	1/4" nps(f)	Used in circulating and heated fluid systems for fluid

N/R = Non-Rated • Pltd brass = Plated brass, chrome • S.S. = Stainless steel  
Galv. = Galvanized steel • Steel pltd = Plated steel, cadmium or zinc • Poly = Polypropylene plastic

## **Air Supply Controls & Gauges**

<b>AIR REGULATORS</b>	<b>7-2</b>
<b>BYPASS AIR REGULATORS</b>	<b>7-4</b>
<b>AIR CONTROL ASSEMBLIES (PUMPS)</b>	<b>7-6</b>
<b>AIR CONTROL ASSEMBLIES (PRESSURE TANKS)</b>	<b>7-7</b>
<b>CENTRIFUGAL AIR FILTERS / REGULATORS</b>	<b>7-8</b>
<b>COALESCER UNITS</b>	<b>7-10</b>
<b>DESICCANT UNITS</b>	<b>7-12</b>
<b>1 STAGE CHARCOAL FILTER</b>	<b>7-14</b>
<b>3 STAGE BREATHING AIR UNIT</b>	<b>7-14</b>
<b>2 STAGE FILTER / REGULATOR</b>	<b>7-14</b>
<b>FILTER ELEMENT KITS</b>	<b>7-16</b>
<b>AIR VIZOR™ BREATHABLE AIR SYSTEMS</b>	<b>7-16</b>
<b>AIR PRESSURE GAUGES</b>	<b>7-17</b>

# Air Supply Controls & Gauges

## HAR Air Regulators

General purpose regulators for line takeoff use or as integral regulators on pumps, pressure tanks and other air operated devices. Require separate trap or filter in air line to remove moisture or dirt.

- Removable plug and cap.
- All metal body; durable Delrin® cap, metal T handle; Buna N diaphragm and disc.
- Accurate regulator mechanism provides precision air control.
- Self-relieving design.
- Both main line and regulated outlets available from same units.

## HAR-501® Air Regulator

Extra Sensitive regulator for use with precision control on pressure feed tanks or other dead-end applications. Can be used to control atomization pressure for one spray gun.

- Self-relieving regulator.
- Tough, reinforced Buna N diaphragm for extended service life.
- 100 mesh stainless steel strainer.
- Removable bottom plug for easy service.
- Forged brass body and stainless steel or brass internal parts for long service.
- High ratio of diaphragm surface to orifice area provides stable uniform regulation.

## Air Regulators

Part Number	Description	Inlet	Outlet(s)	Inlet Press. Max.	Outlet Press. Min.	Outlet Press. Max.	Where Used
107-1343	Air regulator	3/4" npt(f)	1 ea 3/4" npt(f) 2 ea 1/4" npt(f)	250 psi	5 psi	125 psi	101-9251 air control
873465	Air regulator	1/4" npt(f)	3 ea 1/4" npt(f)	n/a	0 psi	125 psi	Raptor – pump
873466	Air regulator	1/4" npt(f)	3 ea 1/4" npt(f)	n/a	0 psi	50 psi	Raptor – atom. air
85-214	Air regulator	1/4" npt(f)	3 ea 1/4" npt(f) Regulated	n/a	0 psi	100 psi	Old style Binks non-ASME pressure tanks
HAR-507	Air regulator	3/8" npt(f)	3 ea 1/4" npt(f)	150 psi	0 psi	125 psi	Pressure tanks
HAR-535	Air regulator	3/8" npt(f)	1/4" npt(f) Unregulated 1/4" npt(f) Regulated 3/8" npt(f) Regulated	250 psi	0 psi	125 psi	General use
HAR-555	Air regulator	3/8" npt(f)	2 ea 1/4" npt(f) Unregulated 1 ea 1/2" npt(f) Regulated	250 psi	0 psi	125 psi	General use
HAR-600	Air regulator w/ gauge	3/8" npt(f)	3 ea 1/4" npt(f)	150 psi	0 psi	125 psi	Pressure tanks and general use
HARG-510	Air regulator w/ gauge	1/4" nps(m)	1/4" nps(f) SWIVEL	200 psi	5 psi	100 psi	Gun atom. air reg. assy.
237-635	Air regulator	1/2" npt(f)	2 ea 1/4" npt 1 ea 1/2" npt(f)	n/a	0 psi	125 psi	Excel pumps – air control
JGHV-453 / KK-4980	Air regulator (mini) regulator kit	1/4" npt(f)	1 ea 1/4" npt(f) 1 ea 1/8" npt(f)	125 psi	0 psi	8 psi	TLC-576, TGC-600, TSC-591 pressure cups
HAR-501	Air regulator (extra sensitive)	3/8" npt(f)	3/8" npt(f)	250 psi	0 psi	20 psi	Pressure tanks
849315	Piggyback filter / air regulator	1/2" npt(f)	1/2" npt(f)	250 psi	5 psi	140 psi	Infinity pumps
85-441	Air regulator	1/4" nps(f)	1/4" nps(f)		2 psi	50 psi	80-295, 80-296, 80-600, 80-651
85-502	Air regulator	3/4" npt	3/4" npt 1/4" npt (x2) Regulated	300 psi	5 psi	150 psi	BX pumps

## HAR-400 Regulator Lockout Accessory

Used with any HAR, T Handle style air regulators.

This device allows the painter to set their air regulators to guarantee proper atomization, as well as to assure compliance in areas where air cap pressure is limited to 10 psi or less. Includes one key per unit.

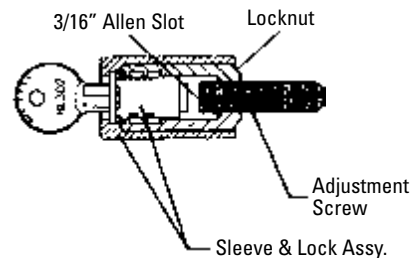



# Air Supply Controls & Gauges



HAR-507



HAR-535  
HAR-555



HARG-510



237-635

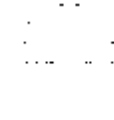

HAR-501



849315



85-441

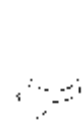

85-502

## Air Regulators

Part Number	Capacity	Type	Gauge	Repair Kit	Service Form
107-1343	n/a	Knob	None	None	77-2315
873465	n/a	Knob	Optional 849306 gauge 0-160	None	None
873466	n/a	Knob	Optional 849314 gauge 0-60	None	None
85-214	30 cfm	Knob	Optional 83-2727 gauge 0-100	6-207	77-1890
HAR-507	60 cfm	T-Handle	Optional GA-288 gauge 0-160	KK-4977	SB-6-147
HAR-535	40 cfm	T-Handle	Optional GA-33 gauge 0-30 or GA-333 gauge 0-100 or GA-288 gauge 0-160	KK-4139-3	SB-6-162
HAR-555	40 cfm	T-Handle	None	KK-4139-3	SB-6-162
HAR-600	60 cfm	T-Handle	Includes GA-288 gauge 0-160	KK-4977	SB-6-147
HARG-510	n/a	Knob	Includes GA-338 gauge 0-160	KB-428-1	SB-6-105
237-635	100 cfm	T-Handle	Optional 83-1290 gauge 0 - 150 psi	237-904	77-2787
JGHV-453 / KK-4980	n/a	Knob	Optional GA-355 gauge 0-30 psi	None	SB-6-102
HAR-501	15 cfm	T-Handle	None	KK-4200	SB-6-131
849315	172 scfm	Knob	Includes GA-338 gauge 0-160 psi	None	876125
85-441	n/a	Knob	Includes 85-70 gauge 0-60 psi	85-438	77-2825
85-502	220 scfm	Knob	None	85-511	None

**SEE PAGE 9-5 FOR AIR ADJUSTING VALVES**

# Air Supply Controls & Gauges



85-215



85-435



85-440

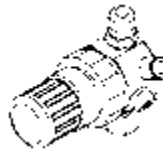

85-448



HAR-511



HAR-508

## Bypass Air Regulators

Part Number	Description	Inlet	Outlet(s)	Inlet Press. Max.	Outlet Press. Min.	Outlet Press. Max.
85-215	Air regulator	1/4" npt(f)	2 ea 1/4" npt(f) regulated 1 ea 1/4" npt(f) unregulated	n/a	0 psi	100 psi
85-435	Air regulator kit	1/4" nps(m)	1 ea 1/4" nps(m) unregulated 1 ea 3/8"-24 (m) regulated 2 ea 1/8" npt(f) regulated	95 psi	0 psi	15 psi
85-440	Air regulator	1/2" npt w/ 1/4" nps(m) conn	1/8" npt(f) unregulated w/ 1/4" nps(f) swivel 1/8" npt(f) regulated w/ 7/16-24 (m) conn 1/8" npt(f) regulated w/ 85-70 gauge 1/8" npt(f) regulated w/ 85-243 55 psi safety valve	95 psi	0 psi	50 psi
85-445	Air regulator	1/2" npt w/ 1/4" nps(m) conn	1/8" npt(f) unregulated w/ 1/4" nps(f) swivel 1/8" npt(f) regulated w/ 3/8-24 (f) conn 1/8" npt(f) regulated w/ 85-70 gauge 1/8" npt(f) regulated w/ 85-243 55 psi safety valve	95 psi	0 psi	50 psi
85-448	Air regulator	1/4" nps(m)	1 ea 1/4" nps(f) 1 ea 1/4" tubing connection	300 psi	0 psi	50 psi
HAR-511	Air regulator	3/8" npt(f)	1/4" npt(f) regulated 3/8" npt(f) regulated 2 1/4" npt(f) unregulated	150 psi	0 psi	125 psi
HAR-508	Air regulator	1/2" npt(f)	2 ea regulated 1/4" npt(f) 1 ea 1/2" npt(f) unregulated	300 psi	0 psi	160 psi

## HAR-400 Regulator Lockout Accessory

Used with any HAR, T Handle style air regulators.

This device allows the painter to set their air regulators to guarantee proper atomization, as well as to assure compliance in areas where air cap pressure is limited to 10 psi or less. Includes one key per unit.

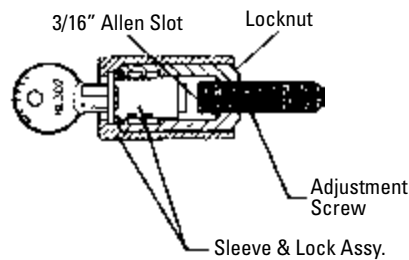

# Air Supply Controls & Gauges

## Bypass Air Regulators

Part Number	Where Used	Capacity	Type	Gauge	Repair Kit	Service Form
<b>85-215</b>	Pogo pump, old tanks	30 cfm	Knob	Optional 83-2727 gauge 0-100	6-207	77-1890
<b>85-435</b>	80-511 1 qt. cup, 98-1141 outfit	n/a	Knob	Includes GA-313 gauge 0-15 plus 35 psi safety valve	85-437	77-2816
<b>85-440</b>	80-295 cup	n/a	Knob	Includes 85-70 gauge 0-60 plus 35 psi safety valve	85-438	77-2817
<b>85-445</b>	80-294 pressure cup	n/a	Knob	Includes 85-70 gauge 0-60 plus 35 psi safety valve	85-438	77-2818
<b>85-448</b>	80-651 cup, agitator assembly	n/a	Knob	none	85-437	77-2843
<b>HAR-511</b>	Pressure tanks	60 cfm	T-handle	Optional 83-1290 gauge 0-150	KK-4977	77-2781
<b>HAR-508</b>	DAD-503 air station, DAD-504 air station, HAF-601 air station, Air Vizor	28 cfm @ 60 psi	Knob	Optional GA-316 gauge 0-160	KK-5045	SB-6-133

# Air Supply Controls & Gauges

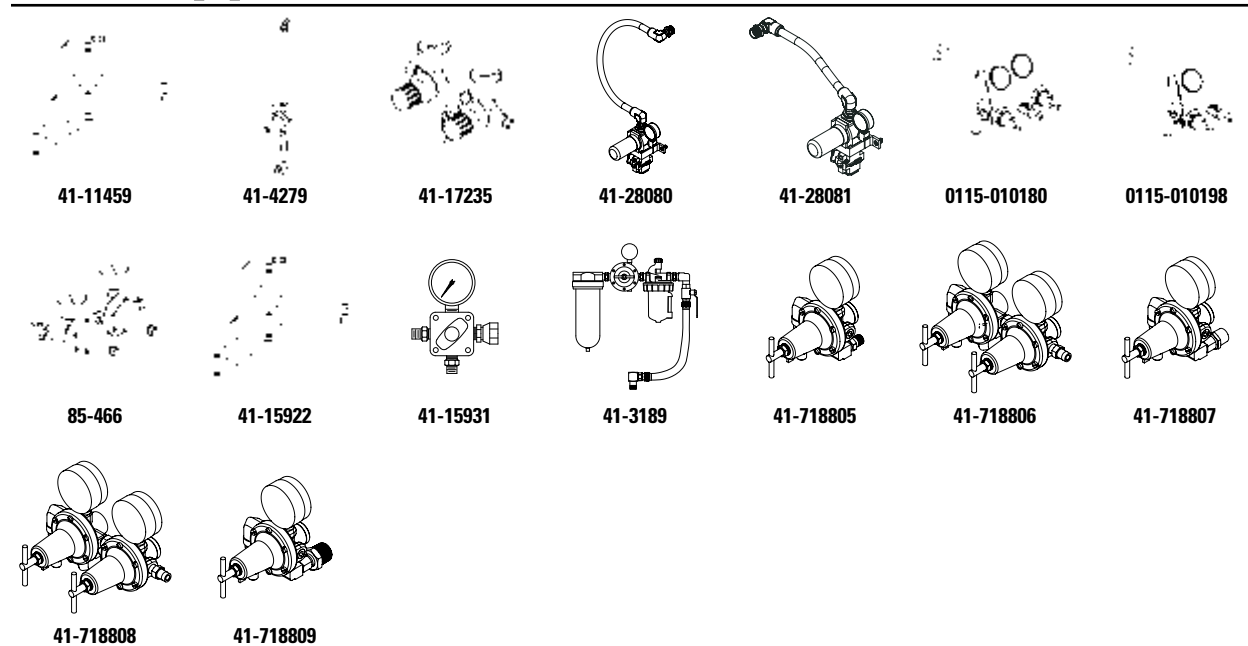

## Air Control Assemblies (Pumps)

Part Number	Description	Pump Air Regulator	Atomizing Air Regulator	Assembly Used On	Max. Working Pressure	Mounting Type	Inlet / Outlet Fitting Sizes	Service Form
41-11459	Dual air reg set	HAR-507	HAR-507	Binks 6" Air mtrs and smaller	100 PSI	Cart / Wall	3/8"	SB-6-147
41-4279	Single air reg set	HAR-507	n/a	Binks 6" Air mtrs and smaller	100 PSI	Cart / Wall	3/8"	77-1737, SBBI-6-147
41-17235	Dual air reg set	HAR-503-2	HAR-503-2	Binks Comet 4/12 Series	100 PSI	Pump	1/4"	77-2887, SB-6-105
41-28080	Single air reg set	85-502	n/a	Binks BX Series	100 PSI	Cart	3/4"	77-2901
41-28081	Single air reg set	85-502	n/a	Binks BX Series	100 PSI	Wall	3/4"	77-2901
0115-010180	Dual air reg set	0115-010183	0115-010182	Binks MX 4/12 Series and MX 4/32	116 PSI	Cart / Wall / Tripod	3/8"	77-2912, 77-2913
0115-010198	Single air reg set	0115-010183	n/a	Binks MX 4/12 Series and MX 4/32	116 PSI	Cart / Wall	3/8"	77-2912, 77-2913
85-466	Dual air reg set	HAR-511	HAR-507	Binks DVP Pumps	100 PSI	Pump	3/8"x1/4"	77-2781, SBBI-6-147
41-15922	Dual air reg set	HAR-507	HAR-507	Binks Comet 3B	80 PSI	Cart / Wall	3/8"	SB-6-147
41-15931	Single air reg set	85-215	n/a	Binks Pogo Pumps	100 PSI	Pump	1/4"	77-1890
41-718805	Single air regulator control	HAR-507	n/a	1/2" Gemini II Diaphragm Pumps	150 psi	Pump	1/4" npt(m) – 1/4" nps(m)	SB-6-147
41-718806	Dual air regulator control	HAR-511	HAR-507	1/2" Gemini II Diaphragm Pumps	150 psi	Pump	1/4" npt(m) – 1/4" nps(m)	SB-6-147 & 77-2781
41-718807	Single air regulator control	HAR-507	n/a	1" Gemini II Diaphragm Pumps	150 psi	Pump	1/2" npt(m) – 1/4" nps(m)	SB-6-147
41-718808	Dual air regulator control	HAR-511	HAR-507	1" Gemini II Diaphragm Pumps	150 psi	Pump	1/2" npt(m) – 1/4" nps(m)	SB-6-147 & 77-2781
41-718809	Single air regulator control	HAR-507	n/a	1-1/2" Gemini II Diaphragm Pumps	150 psi	Pump	3/4" npt(m) – 1/4" nps(m)	SB-6-147
41-28272	Dual air regulator control	HAR-503-2	HAR-503-2	MX LITE Pumps	100 psi	Pump	1/4" npt(m) – 1/4" nps(m)	SB-6-105
41-28190	Single air regulator control	85-502	n/a	MX-3560, MX-3070 & MX-35AA	150 PSI	Pump	3/4" npt(m) – 3/4" npt(m)	77-1890

# Air Supply Controls & Gauges

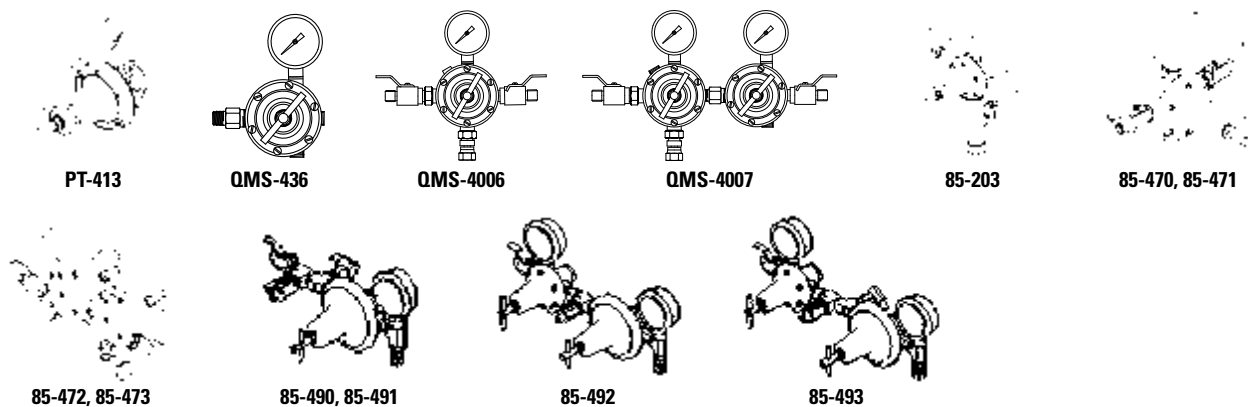

## Air Control Assemblies (Pressure Tanks)

Part Number	Description	Tank Air Regulator	Atomizing Air Regulator	Assembly Used On Tanks	Max. Working Pressure	Inlet / Outlet Fitting Sizes	Service Form
PT-413	Conversion kit for dual	n/a	HAR-507	PT 2.8 (80lb tanks)	80 PSI	1/4"nps	SBBI-21-921
QMS-436	Conversion kit for dual	n/a	HAR-507	83- 2.8 through 60 gal (110 psi)	100 PSI	1/4"nps	SBBI-21-913
QMS-4006	Single regulator kit	HAR-511	n/a	83- 2.8 thru 15 gal (110 psi)	100 PSI	1/4"nps	SBBI-21-XXX
QMS-4007	Dual regulator kit	HAR-511	HAR-507	83- 2.8 through 15 gal (110 psi)	100 PSI	1/4"nps	SBBI-21-XXX
85-203	Single air reg kit	HAR-511	n/a	83- 30 through 60 gal (110 psi)	100 PSI	1/4"nps	77-1827
85-470	Single regulator (non agitated tank)	HAR-511	none	183- 2 through 15 gal (110 psi)	100 PSI	1/4"nps	77-2927 77-2928
85-471	Single regulator (agitated tank)	HAR-511	none	183- 2 through 15 gal (110 psi)	100 PSI	1/4"nps	77-2927 77-2928
85-472	Double regulator (non agitated tank)	HAR-511	HAR-507	183- 2 through 15 gal (110 psi)	100 PSI	1/4"nps	77-2927 77-2928
85-473	Double regulator (agitated tank)	HAR-511	HAR-507	183- 2 through 15 gal (110 psi)	100 PSI	1/4"nps	77-2927 77-2928
85-490	Extra sensitive single regulator (non agitated tank)	HAR-501	none	183- 2 through 15 gal (110 psi)	30 PSI	1/4"nps	77-2927 77-2928
85-491	Extra sensitive single regulator (agitated tank)	HAR-501	none	183- 2 through 15 gal (110 psi)	30 PSI	1/4"nps	77-2927 77-2928
85-492	Extra sensitive double regulator (non agitated tank)	HAR-501	HAR-507	183- 2 through 15 gal (110 psi)	30 PSI	1/4"nps	77-2927 77-2928
85-493	Extra sensitive double regulator (agitated tank)	HAR-501	HAR-507	183- 2 through 15 gal (110 psi)	30 PSI	1/4"nps	77-2927 77-2928

# Air Supply Controls & Gauges

## DeVilbiss offers a complete line of quality air filtering units

It's the equipment you need to ensure a contaminant-free material application — because today's high solids and waterbornes are even more sensitive to contaminants. The right filter equipment from DeVilbiss can make all the difference.

The fact is, an otherwise great finish can be totally ruined by just a small amount of dirt, oil or water in your air line. And needless to say, flaws like pinholes, blushing, fisheyes or dulling mean a job has to be redone—a waste of both time and money.

## Quality Equipment and Proper Installation

Following some key installation principles will help decrease the risk of contaminants:

- It's important to use the right size air compressor for your application. An overworked air compressor can produce a significant amount of dirt and oil.

- Proper piping is very important to help prevent condensation from forming within the line and contaminating the air supply.

DeVilbiss is ready to assist you with any questions.



### Centrifugal Air Filters

Part Number	Description	Inlet	Outlet(s)	Inlet Press. Max.	Outlet Press. Min.	Outlet Press. Max.
HAF-502	Centrifugal air filter	1/2" npt(f)	1/2" npt(f)	150 psi	0 psi	150 psi
HAF-503	Centrifugal air filter	3/4" npt(f)	3/4" npt(f)	150 psi	0 psi	150 psi
HAF-505	Coalescing air filter	1/2" npt(f)	1/2" npt(f)	150 psi	0 psi	150 psi

# Air Supply Controls & Gauges

## Recommended Air Supply Setup

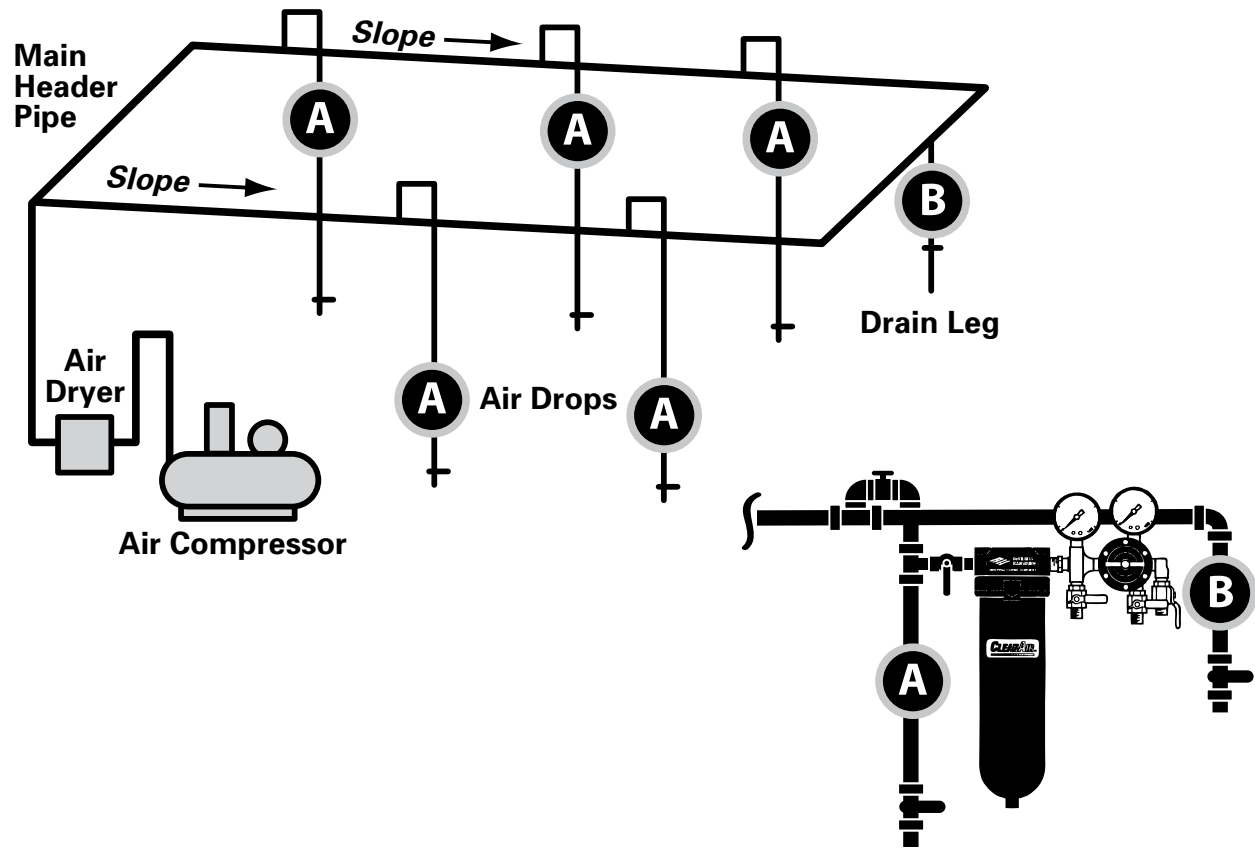

## Centrifugal Air Filters

Part Number	Capacity	Type	Gauge	Repair Kit	Service Form
HAF-502	100 cfm@ 90 psi	In-line	None	None	SB-6-146
HAF-503	150 cfm@ 90 psi	In-line	None	None	SB-6-148
HAF-505	55 cfm@ 90 psi	In-line	None	None	SB-6-152

# Air Supply Controls & Gauges



849315

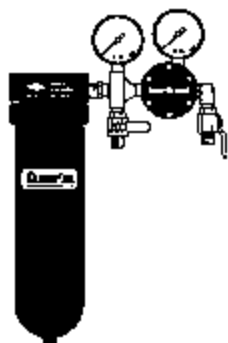

HFRL-508

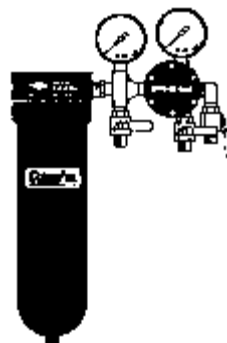

HFRL-509

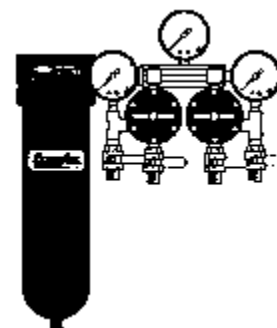

HFRL-511

## Centrifugal Filter/Regulator Units

Part Number	Description	Inlet	Outlet(s)	Inlet Press. Max.	Outlet Press. Min.	Outlet Press. Max.
849315	Piggyback filter / air regulator	1/2" npt(f)	1/2" npt(f)	250 psi	5 psi	140 psi
HFRL-508	Centrifugal filter / regulator unit	1/2" npt(f)	2 ea 1/4" nps(m) regulated and 1 ea 1/4" nps(m) non-regulated	150 psi	0 psi	150 psi
HFRL-509	Centrifugal filter / regulator unit	3/4" npt(f)	2 ea 1/4" nps(m) regulated and 1 ea 1/4" nps(m) non-regulated	150 psi	0 psi	150 psi
HFRL-511	Centrifugal filter / regulator unit	3/4" npt(f)	4 ea 1/4" nps(m) regulated and 1 ea 1/4" nps(m) non-regulated	150 psi	0 psi	150 psi



HAF-508



HAF-509

DeVilbiss CleanAir centrifugal units supply cleaner, drier air to each spray gun in a system. This cleaner air can also increase the life of pneumatic tools.

- Filters out water and oil aerosols and dirt particulates to 5 microns.
- Ideal for most spray applications, air tools and equipment.
- Water droplets collected in the bowl are removed by an automatic drain (standard feature). No need to manually drain.

## Coalescer and Centrifugal/Coalescer Filter Units

Part Number	Description	Inlet	Outlet(s)	Inlet Press. Max.	Outlet Press. Min.	Outlet Press. Max.
HAF-508	Coalescer filter unit	3/4" npt(f)	3/4" npt(f)	150 psi	0 psi	150 psi
HAF-509	Centrifugal & coalescer filter unit	3/4" npt(f)	3/4" npt(f)	150 psi	0 psi	150 psi
41-28191	Centrifugal & coalescer filter unit	3/4" npt(f)	1/2" npt(f)	150 psi	0 psi	150 psi



# Air Supply Controls & Gauges

## Centrifugal Filter/Regulator Units

Part Number	Capacity	Type	Gauge	Dimensions	Repair Kit	Service Form
849315	172 CFM	Piggyback filter / regulator	GA-338 / 0-160 psi	n/a	863023	876125
HFRL-508	60 +	In-line	GA-288 / 83-2727	n/a	KK-4977	SB-6-146
HFRL-509	80 +	In-line	GA-288 / 83-2727	10-3/4" wide x 17-3/4" high	KK-4977	SB-6-148
HFRL-511	120 +	In-line	GA-288 / 83-2727	12-1/2" wide x 17-1/2" high	KK-4977	SB-6-148

CleanAir coalescer filters remove water, dirt and oil from the system down to .01 micron. DeVilbiss coalescer filter units are designed with a quick-release bowl and spin-off element for filter changes without tools. In addition, a filter-change indicator alerts the operator when the element requires changing.

- Borosilicate glass microfiber filter is engineered for high flow, high efficiency, quick change and low pressure drop.
- Ideal for most spray applications, especially where oil aerosols may be a problem.
- Automatic bowl drain and 6' hose eliminate oil and water buildup (standard feature). No need to manually drain.

## Coalescer and Centrifugal/Coalescer Filter Units

Part Number	Capacity	Type	Gauge	Dimensions	Repair Kit	Service Form
HAF-508	150 cfm	In-line	None	4-1/2" wide x 13-3/4" high	KK-4977	SB-6-148
HAF-509	150 cfm	In-line	None	9-1/2" wide x 13-3/4" high	KK-4977	SB-6-148
41-28191	150 cfm	In-line	GA-316, 0-150 psi	19" wide x 13-3/4" high		SB-6-148

# Air Supply Controls & Gauges

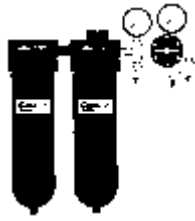

HFRL-512

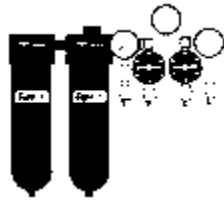

HFRL-513

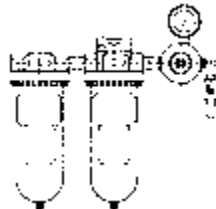

HAF-518

## Centrifugal/Coalescer/Filter Regulator Units

Part Number	Description	Inlet	Outlet(s)	Inlet Press. Max.	Outlet Press. Min.	Outlet Press. Max.
HFRL-512	CENTRIFUGAL - coalescer - filter regulator unit	3/4" npt(f)	2ea 1/4" nps(m) regulated and 1, 1/4" nps(m) non-regulated	150 psi	0 psi	150 psi
HFRL-513	CENTRIFUGAL - coalescer - filter regulator unit	3/4" npt(f)	4ea 1/4" nps(m) regulated	150 psi	0 psi	150 psi
HAF-518	CENTRIFUGAL - coalescer - filter regulator unit	3/4" npt(f)	1ea 1/4" nps(m) regulated	150 psi	0 psi	150 psi



The three-stage desiccant unit provides the ultimate in clean dry air. First stage centrifugal filter removes particulates to 5 microns. Stage two coalescer filters down to .01 micron. Third stage desiccant removes remaining water vapor to a dew point of -40°F.

- Ideally suited for low to medium production.
- DAD-500 air-drying system includes three filtering units, as well as a wall mount bracket and desiccant filter change indicator.

## 3 Stage Desiccant Filter Unit

Part Number	Description	Inlet	Outlet(s)	Inlet Press. Max.	Outlet Press. Min.	Outlet Press. Max.
DAD-500	3 Stage desiccant air dryer	1/2" npt(f)	1/4" nps(m) regulated	150 psi	0 psi	150 psi



- Converts shop air into clean, dry, contaminant-free air for breathing systems and spray operations
- 5 micron particulate filter (Stage 1)

- .01 micron coalescing filter (Stage 2)
- Charcoal filter for hydrocarbon and odor removal (Stage 3)
- 28 cfm breathing air regulator

## 4 Stage Desiccant Filter Unit

Part Number	Description	Inlet	Outlet(s)	Inlet Press. Max.	Outlet Press. Min.	Outlet Press. Max.
DAD-503	4 Stage desiccant air dryer breathable	1/2" npt(f)	1/4" nps(m) regulated & breathable air outlet quick disconnect	150 psi	0 psi	150 psi

# Air Supply Controls & Gauges

## Coalescer/Filter Regulator Units

Part Number	Capacity	Type	Gauge	Dimensions	Repair Kit	Service Form
HFRL-512	80 +	In-line	GA-372 / GA-373	15-3/4" wide x 17-3/4" high	KK-4977	SB-6-145, SB-6-148
HFRL-513	120 +	In-line	GA-372 / 2ea GA-373	21" wide x 17-1/2" high	KK-4977	SB-6-145, SB-6-148
HAF-518	55 cfm	In-line	GA-288	23" wide x 22" high	KK-4977	SB-6-146, SB-6-152, SB-6-140

- Centrifugal and coalescer units include automatic bowl drain (standard feature). No need to manually drain.
- Coalescer filter includes filter change indicator.
- Desiccant filter includes sight glass indicator (Changes color when desiccant needs replacement).

## 3 Stage Desiccant Filter Unit

Part Number	Capacity	Type	Gauge	Shipping Weight	Repair Kit	Service Form
DAD-500	25 cfm	Key / t-handle / in-line	GA-288	35 lbs	KK-4977	SB-6-156

- Desiccant system removes water vapor for spray gun (rated for 25 cfm maximum flow)
- 60 cfm spray gun regulator
- Automatic drains (Stages 1, 2 and 3)
- Can be used with up to four Air Vizors

## 4 Stage Desiccant Filter Unit

Part Number	Capacity	Type	Gauge	Repair Kit	Service Form
DAD-503	25 cfm / 60 cfm	Key / t-handle / in-line	GA-288 / GA-316	KK-5045 diaphragm kit	SB-6-159

# Air Supply Controls & Gauges

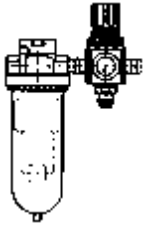

DAD-504

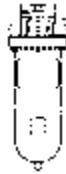

HAF-517

- Converts DAD-500 into a breathing air source
- Charcoal filter for hydrocarbon and odor removal
- 28 cfm breathing air regulator. Includes all necessary fittings
- Can be used with up to four DeVilbiss Air Vizors
- Automatic drain

## 1 Stage Charcoal Filter with Regulator

Part Number	Description	Inlet	Outlet(s)	Inlet Press. Max.	Outlet Press. Min.	Outlet Press. Max.
DAD-504	1 Stage charcoal filter and regulator kit	1/2" npt(f)	1/2" npt(m)	150 psi	0 psi	150 psi
HAF-517	1 Stage charcoal filter only	1/2" npt(f)	1/2" npt(f)	150 psi	0 psi	150 psi

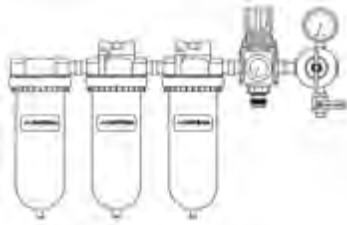

- Converts shop air into clean, contaminant-free air for breathing systems and spray operations
- 5 micron particulate filter (Stage 1)
- .01 micron coalescing filter (Stage 2)
- Charcoal filter for hydrocarbon and odor removal (Stage 3)
- 28 cfm breathing air regulator
- 60 cfm spray gun regulator

## 3 Stage Breathing Air Filter with Regulators

Part Number	Description	Inlet	Outlet(s)	Inlet Press. Max.	Outlet Press. Min.	Outlet Press. Max.
HAF-601	3 Stage breathing air filter with regulators	1/2" npt(f)	1/4" nps(m) & breathable air outlet quick disconnect	150 psi	0 psi	150 psi



## A unique product in the finishing market

- FRC-650 All-In-One combines a filter, regulator and coalescer for shop air into one compact unit.
- Four 1/4" nps(m) ball valves with unrestricted air passages, (three regulated plus one unregulated outlet.)

## 2 Stage Filter/Regulator and Coalescer

Part Number	Description	Inlet	Outlet(s)	Inlet Press. Max.	Outlet Press. Min.	Outlet Press. Max.
FRC-650	All in one – filter, regulator, coalescer	1/2" npt(f)	1/4" nps(m) 3 reg & 1 main line air	150 psi	0 psi	125 psi

# Air Supply Controls & Gauges

## 1 Stage Charcoal Filter with Regulator

Part Number	Capacity	Type	Gauge	Repair Kit	Service Form
<b>DAD-504</b>	28 cfm	Knob / in-line	GA-316	See lit	SB-6-176
<b>HAF-517</b>	28 cfm	N/A	N/A	N/A	SB-6-176

- Automatic drains (Stages 1, 2 and 3)
- Wall-mount bracket
- Can be used with up to four Air Visors

## 3 Stage Breathing Air Filter with Regulators

Part Number	Capacity	Type	Gauge	Repair Kit	Service Form
<b>HAF-601</b>	28 cfm / 60 cfm	Knob / t-handle / in-line	GA-288 / GA-316	See lit	SB-6-132

- Ball valves inclined 45°—avoids kinking of hoses, which increases life span.
- Robust and durable.
- Solvent-resistant filter bowl and body is indispensable in the spray area.
- Solvent- and slip-resistant knob for easy air adjustment.
- Automatic drains at each stage eliminate water build-up—no need to manually drain.

## 2 Stage Filter/Regulator and Coalescer

Part Number	Capacity	Type	Gauge	Repair Kit	Service Form
<b>FRC-650</b>	100 cfm	Knob	FRC-012 / FRC-046	K-4106/7/8	SB-6-377

# Air Supply Controls & Gauges



HAF-6, HAF-15,  
HAF-28, HAF-36



HAF-38

## Filter Element Kits / Mounting Hardware Kits

Filter Assy. Part Number	Filter Element Kit	Mounting Hardware Kit Optional Parts	Service Form
DAD-500	HAF-6, HAF-28, DAD-1	n/a	SB-6-156
DAD-503	HAF-6, HAF-28, HAF-36, DAD-1	HAF-407	SB-6-159
FRC-650	K-4106	K-4107	SB-6-377
DAD-504	HAF-36	n/a	SB-6-176
HAF-502	HAF-6	HAF-407	SB-6-146
HAF-503	HAF-15	HAF-408	SB-6-148
HAF-505	HAF-28	n/a	SB-6-152
HAF-508	HAF-38	HAF-408	SB-6-148
HAF-509	HAF-15, HAF-38	HAF-408	SB-6-148
HAF-601	HAF-6, HAF-28, HAF-36	HAF-407	SB-6-132
HFRL-508	HAF-6	HAF-407	SB-6-146
HFRL-509	HAF-15	HAF-408	SB-6-148
HFRL-511	HAF-15	HAF-408	SB-6-148
HFRL-512	HAF-15, HAF-38	HAF-408	SB-6-148
HFRL-513	HAF-15, HAF-38	HAF-408	SB-6-148
849303	873209	849305	849303
849315	863022	n/a	876125

# Air Supply Controls & Gauges

**GA-288**

**GA-385**

## Air Pressure Gauges

Part No.	Capacity Pressure	Thread Size & Position		Notes
		Bottom	Back	
59-299	15		1/8" npt(m)	Panel mount, 1-1/2" diameter
83-1636	15	1/4" npt(m)		2-11/16" diameter
GA-313	15	1/8" npt(m)		1-1/2" diameter
83-1414	30	1/4" npt(m)		2-1/2" diameter
GA-73	30	1/4" npt(m)		2" diameter
GA-355	30	1/8" npt(m)		1-1/2" diameter
59-369	60		1/8" npt(m)	Panel mount, 1-1/2" diameter
85-70	60	1/8" npt(m)		1-5/8" diameter, replacement lens 85-130-5
83-490	100	1/8" npt(f)		2" diameter
83-1355	100	1/4" npt(m)		Plated stem, 2-1/2" diameter
83-2727	100	1/4" npt(m)		83-2290 (Lens), 2-3/16" diameter
GA-385	100		1/4" npt(m)	2" diameter
83-1290	150	1/4" npt(m)		Used on tanks, 2-1/2" diameter, replacement lens 83-2052
GA-288	160	1/4" npt(m)		2" diameter
GA-316	160		1/4" npt(m)	2" diameter
GA-338	160		1/8" npt(m)	1-1/2" diameter (replacement gauge for 849315 filter regulator)
83-2744	200	1/4" npt(m)		2-11/16" diameter
83-387	200	1/4" npt(m)		83-2052 (Lens), 2-1/2" diameter





## Cups & Cup Accessories

<b>SIPHON CUPS</b>	<b>8-2</b>
<b>PRESSURE CUPS</b>	<b>8-3</b>
<b>GRAVITY FEED CUPS</b>	<b>8-4</b>
<b>REMOTE PRESSURE CUPS</b>	<b>8-5</b>
<b>DEKUPS DISPOSABLE CUP SYSTEM</b>	<b>8-6</b>
<b>CUP ACCESSORIES</b>	<b>8-8</b>
<b>CUP GASKETS</b>	<b>8-8</b>

# Cups & Cup Accessories

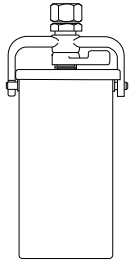

81-540

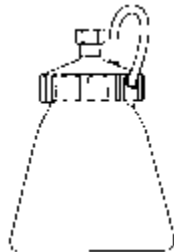

81-384



TGS-503



TGS-406

## Siphon Cups – 1/4" nps Thread For Touch-up Guns

Part Number	Capacity	Wetted Materials	Type	Notes	Service Form
81-540	8 oz	Aluminum	Standard		77-1261
81-384	8 oz	Polyethylene	Drip proof		77-2741
TGS-503	8 oz	Polyethylene	Standard		SB-4-090
TGS-406	8 oz	Polyethylene	Standard	Storage cup with lid	n/a

NOTE: To use on full size spray guns, use adapter P-H-4105.



TGC-545, TLC-555,  
TSC-595



81-800, 81-810



81-820



81-352

## Siphon Cups – 3/8" nps Thread For Full Size Guns

Part Number	Capacity	Wetted Materials	Type	Guns Used With	Service Form
TGC-545	1 qt	Aluminum	Drip-free	All full size guns	SB-4-391
81-800	1 qt	Aluminum	Drip proof	All full size guns	77-2794
TLC-555	1 qt	Aluminum w/ non-stick coating	Drip-free	All full size guns	SB-4-391
81-810	1 qt	Aluminum w/ non-stick coating	Drip proof	All full size guns	77-2795
TSC-595	1 qt	Stainless steel	Drip-free	All full size guns	SB-4-395
81-820	1 qt	Stainless steel	Drip proof	All full size guns	77-2821
81-352	1 qt	Center Post Assembly		All full size guns	

# Cups & Cup Accessories



81-382

## Pressure Cup (gun attached) – 1/4" nps Thread For Mach 1 Cub and CubSL only

Part Number	Capacity	Wetted Materials	Max. Pressure	Guns Used With	Service Form
81-382	8 oz	Polyethylene	10 psi	MACH 1 Cub & Cub SL only	77-2724

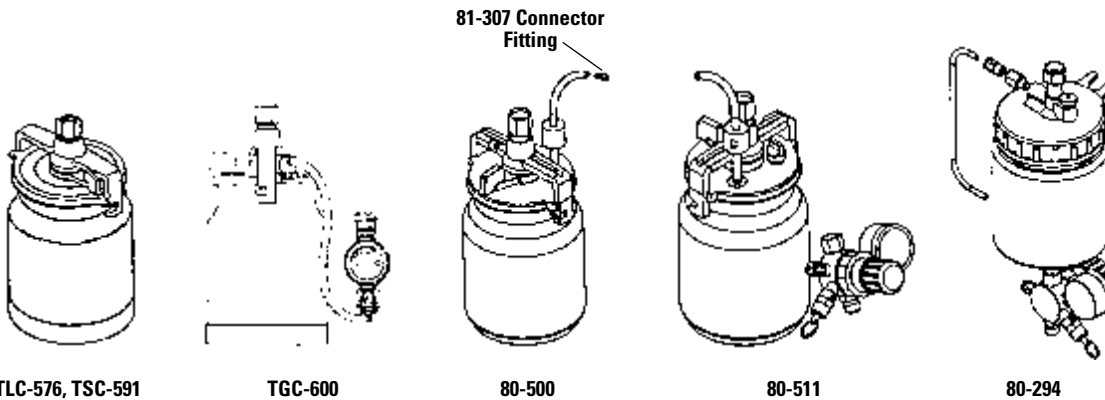

TLC-576, TSC-591

TGC-600

80-500

80-511

80-294

## Pressure Cups (gun attached) – 3/8" nps Thread For Full Size Guns

Part Number	Capacity	Wetted Materials	Max. Pressure	Notes	Service Form
TLC-576	1 qt	Aluminum w/ non-stick coating	20 psi	Requires KK-4980	SB-4-367
TGC-600	1 qt	Aluminum	20 psi	Includes KK-4980	SB-4-367
TSC-591	1 qt	Stainless steel	20 psi	Requires KK-4980	SB-4-367
80-500	1 qt	Stainless steel	20 psi	Includes short tube (MACH 1 & MACH 1SL only) and 81-507 connector fitting	77-2820
80-510	1 qt	Stainless steel	15 psi	Includes long tube (requires 85-435 regulator)	77-2820
80-511	1 qt	Stainless steel	15 psi	Includes long tube, 85-435 regulator	77-2820
80-294	1 qt	Aluminum	50 psi max	Includes tube, 85-445 regulator	77-2822

# Cups & Cup Accessories



54-4458

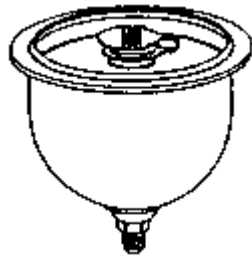

81-381

## Gravity Feed Cups – 7/16" -14 (m) Thread for Touch-up Guns

Part Number	Capacity	Wetted Materials	Service Form
54-4458	4 oz / 120 ml	Aluminum	77-2719
SRI-478-K12	4 oz / 120 ml	Nylon (disopsable)	SB-2-525
SRI-510	4 oz / 120 ml	Acetal	SB-2-525
81-381	8 oz / 240 ml	Aluminum	77-2739

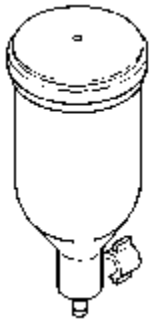

KG-250

## Gravity Feed Cup – 1/4" -19 bsp (f) Swivel (For TGHV-635 Gun Only)

Part Number	Capacity	Wetted Materials	Service Form
KG-250	8 oz / 250 ml	Aluminum	—

# Cups & Cup Accessories



GFC-501

## Gravity Feed Cups – 3/8”-19 bsp (m) Thread For Full Size Guns

Part Number	Capacity	Wetted Materials	Guns Used With	Service Form
KGP-509-1	8 oz / 240 ml	Nylon	EXL, M1-G, FLG-2, FLG-3, Compact, 95G, SV-100	SB-4-042
GFC-501	20 oz / 590 ml	Acetal, plated brass fittings	EXL, M1-G, FLG-2, FLG-3, Compact, 95G, SV-100	SB-4-261
GFC-502	34 oz / 1 Liter	Aluminum	EXL, M1-G, FLG-2, FLG-3, Compact, 95G, SV-100	SB-4-043
54-4720	34 oz / 1 Liter	Aluminum	EXL, M1-G, FLG-2, FLG-3, Compact, 95G, SV-100	SBBI-4-043

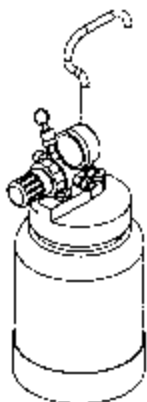

80-295



KB-555, KB-545-SS

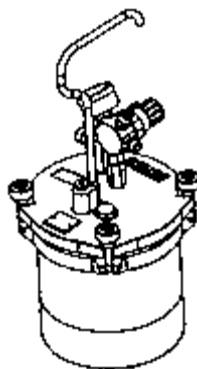

80-600, 80-601, 80-651

## Pressure Cups (remote from gun)

Part Number	Capacity	Wetted Materials	Max. Working Pressure	Notes	Service Form
80-295	2 Quart / 1895 ml	Aluminum	50 psi	Single regulator (fluid pressure)	77-2823
KB-555	2 Quart / 1895 ml	Aluminum	50 psi	Single regulator (fluid pressure)	SB-4-205
80-600	2 Quart / 1895 ml	Aluminum & stainless steel	50 psi	Single regulator (fluid pressure)	77-2841
KB-545-SS	2 Quart / 1895 ml	Stainless steel	50 psi	Single regulator (fluid pressure)	SB-4-205
80-601	2 Quart / 1895 ml	Aluminum & stainless steel	50 psi	Single regulator (fluid pressure), oscillating agitator	77-2841
80-651	2 Quart / 1895 ml	Aluminum & stainless steel	50 psi	Single regulator (fluid pressure) and rotary agitator w/reg.	77-2842

# Cups & Cup Accessories

## DeKups Disposable Cup System

### CUP SYSTEMS

Part Number	Description	Notes
DPC-607	Reusable frame, 9 oz	Kit of 2
DPC-606	Reusable frame, 24 oz	Kit of 2
DPC-608	Reusable frame, 34 oz	Kit of 2
DPC-602	Disposable cup, 9 oz	Kit of 32
DPC-601	Disposable cup, 24 oz	Kit of 32
DPC-600	Disposable cup, 34 oz	Kit of 32

### GRAVITY ADAPTERS

Part Number	Compatible Spray Gun
DPC-31	Compact, JGA, EXL, FLG, M1-G, 95-G, SV100
DPC-23	SRI, Cub SLG, Compact Mini
DPC-10	SV50 Full Size, Graco Finex
DPC-64	SV50 Touch Up
DPC-43	Graco® XT, Graco GT
DPC-77	Graco® AirPro
DPC-78	Kremlin® Guns

### SIPHON FEED ADAPTERS

Part Number	Compatible Spray Gun
DPC-79-K1	Siphon: Mach 1 Cub, Mach 1 Cub SL, EGA, EGHV, 115
DPC-69-K1	Siphon Conversion Adapter (full size guns)
DPC-500	Converter for 3M® Adapters

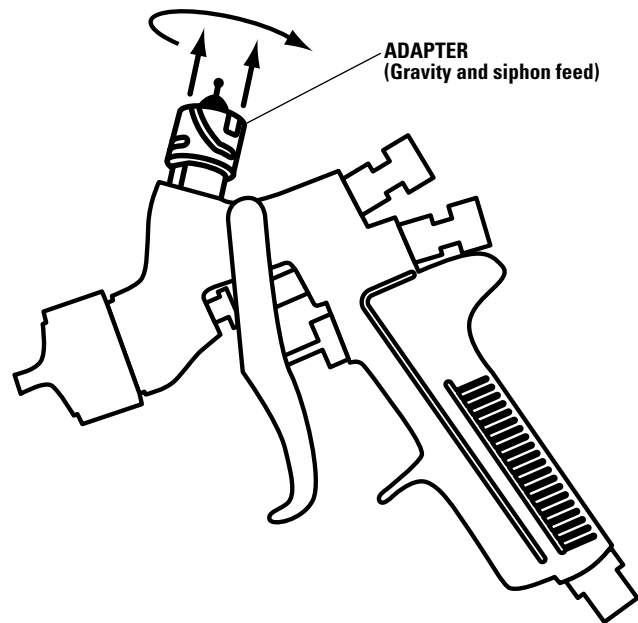
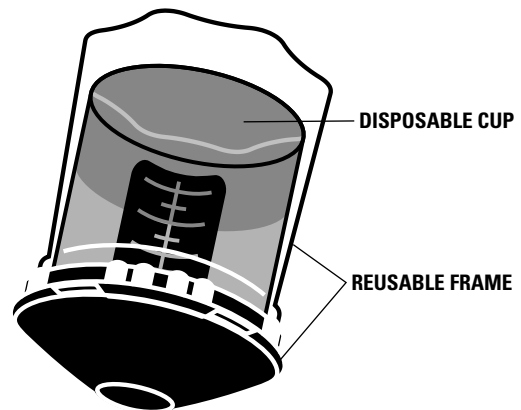

U.S. Patent Nos. 6,820,824 and 7,374,111  
owned by 3M Innovation Properties Co.

Additional U.S. Patents: Nos. 7,380,680; 7,354,074;  
7,353,964; 7,350,418; 7,344,040; 7,263,893;  
7,165,732; 7,086,549.

# Cups & Cup Accessories

## DeKups Disposable Cup System

### BETTER FLUID FLOW FOR GREAT COLOR MATCH

The DeKups liner features high collapsibility, so all the paint is moved through the gun and onto the job. Save time and money, increase productivity, and waste less paint.

### POSITIVE LOCKING LID

The reusable DeKups lid locks firmly into place and will not come detached from the gun while in use. No messy accidents.

### REFILL WITHOUT OPENING THE CUP LID

Patented self-venting funnels allow a painter to refill without opening the cup lid. No mess on the bench during the refill process saves clean-up time, wasted paint, and money.

### SELF-DISPENSING PACKAGING

The versatile dispensers mount conveniently on the wall so you can put them wherever you like. No space restrictions, no need to refill bins. Each cup and lid dispenses separately for less hassle. Save time and space.

### LARGER VOLUMES

DeKups offers 9–50 percent more cup volume—which means less refills. With three different cup sizes, you can size the cup to the job, wasting less paint, saving more money.

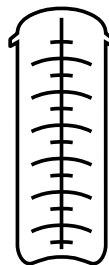

DPC-60-K10,  
DPC-59-K10,  
DPC-61-K10

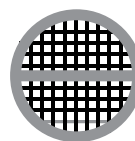

DPC-65-K24, DPC-42-K24,  
DPC-67-K24, DPC-66-K24

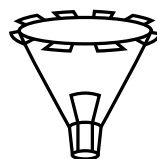

DPC-22-K24



DPC-6-K10



DPC-44

### ACCESSORIES

Part Number	Description	Notes
DPC-60-K10	Measuring Guide 9 oz	Kit of 10
DPC-59-K10	Measuring Guide 24 oz	Kit of 10
DPC-61-K10	Measuring Guide 34 oz	Kit of 10
DPC-65-K24	Disk Filters 125 micron 9 oz	Kit of 24
DPC-42-K24	Disk Filters 125 micron 24 oz & 34 oz	Kit of 24
DPC-67-K24	Disk Filters 200 micron 9 oz	Kit of 24
DPC-66-K24	Disk Filters 200 micron 24 oz & 34 oz	Kit of 24
DPC-22-K24	Disposable Funnels	Kit of 24
DPC-6-K10	Orange Plugs	Kit of 10
DPC-44	Cleaning Brush	Each

# Cups & Cup Accessories



TGS-406



149-278



KR-115-K5



KK-5051

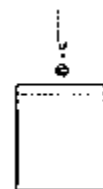

OMX-70-K48



KGP-5-K5



81-82, 81-83, 81-84

## Cup Accessories

Part Number	Description	Notes
TGS-406	Storage cup with lid	Compatible with TGS-503 suction cup
149-278	Siphon/suction cup inlet screen 50 mesh, brass	Fits on p/u tube, 10 Per box
KR-115-K5	Diaphragm lid protector	Prevents cup leaks, package of 5
KK-5051	KB cup liners 20/pkg	For KB-545-SS & KB-555 2 qt cups
OMX-70-K48	Gravity cup liners & bushings	Fits most 1 qt & 1 liter cups
KGP-5-K5	Gravity cup strainers 50 mesh,	Package of 5
81-82	145 Mesh 1 quart cup strainers	Approximately 100 micron, box of 5
81-83	100 Mesh 1 quart cup strainers	Approximately 149 micron, box of 5
81-84	80 Mesh 1 quart cup strainers	Approximately 177 micron, box of 5
80-356	Semi-rigid liners	For Binks SG2 cups, box of 12

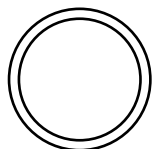

## Cup Gaskets

Part Number	Cup Model	Gasket Material	Notes
KGP-13-K5	Gravity feed cups with 3/8"-19 bsp(m) threads	PTFE	Package of 5
KB-80-K5	KB-545SS and KB-545	Sarlink	Package of 5
TGC-9-K5	TGC, TLC, TSC, 81-800, 81-810, 81-820, 81-500, 81-510 and 81-511	Tri-Seal	Package of 5
55-30	81-540	Leather	Each
TGS-4-K5	TGS-503	Tri-Seal	Package of 5
80-11-5	80-294 and 80-295	Tri-Seal	Package of 5
80-506-K5	TGC, TLC, TSC, 81-800, 81-810, 81-820, 81-500, 81-510 and 81-511	X-1232 (proprietary formula)	Package of 5
80-392	80-600, 80-601, 80-651, 80-350, 80-351 and 80-451	EPDM	Each



## **Spray Gun Accessories & Misc. Products**

**SPRAY GUN CLEANING KITS, BRUSHES & TOOLS 9-2**

**SOLVENT SAVER (HOSE GUN CLEANER) 9-3**

**SPRAY GUN & PUMP LUBRICANTS / FLUIDS 9-3**

**SPRAY GUN ACCESSORIES 9-4**

**AIR REGULATORS 9-5**

**SPRAY GUN STANDS (GRAVITY FEED GUNS) 9-6**

**MISC. PRODUCTS 9-6**

# Spray Gun Accessories & Misc. Products



192212



OMX-88



42884-215-K10



42884-214-K5



KK-5060



DPC-44



WR-103

## Spray Gun Cleaning Kits, Brushes & Tools

Part Number	Description	Notes
192212	Professional spray gun cleaning kit	Works for all guns
54-4994	Gun cleaning kit	Includes: wire tool tip cleaner, 1/4" dia round brush, flat brush
OMX-88	Flat brush	Cleaning brush (semi-rigid)
54-4133	1/4" Dia round brush	For cleaning of air & fluid passages
82-469	5/8" Dia round brush	For cleaning of air & fluid passages
42884-215-K10	5/8" Dia spiral brush	Package of 10, for cleaning of air & fluid passages
42884-214-K5	3/8" Dia spiral brush	Package of 5, for cleaning of air & fluid passages
DPC-44	Cleaning brush (DeKups)	For funnels, cups & spray gun passages
KK-5060	Air cap cleaning kit	Includes: wire tool, 1/4" diameter spiral brush, 3/32" diameter spiral brush
237-707	1-80 mil wet film mil gauge	
5-476	Gun wrench (2100, 21 and 2001)	
54-4213	Gun wrench (95, 95SL and 95A)	
54-3918	Gun wrench (Mach 1, Mach 1SL and MI-G)	
73-165	11/32" Hex key wrench (7, 18, 2001 gun head removal)	
20-2002	1/8" Hex key for 7D and 7E2 needles	
20-1576	3/16" Hex key for 43P gun	
WR-103	Gun wrench (DeVilbiss spray guns)	For fluid tips, fittings & bushings
SPN-5	Gun wrench (Compact series)	
SRI-50-K2	Gun wrench (SRI)	
54-1634	Tip Cleaning Needle	

# Spray Gun Accessories & Misc. Products



HD-503, 183GZ-5200



KK-5052  
(Lid & cup not included)

## Solvent Saver (Hose Gun Cleaner)

Part Number	Description	Notes
183GZ-5200	Solvent saver	2 Gallons
HD-503	Hose/gun cleaner	2 Quarts
KK-5052	Adapter fitting and hose kit	For solvent saver & KB series cups



863009, 42-175, 207-11155, 863020



SSL-10-K12



6-429



0114-009433, 0114-014871

## Spray Gun & Pump Lubricants / Fluids

Part Number	Description
41-3134	Binks Pump Purge, case of 12
41-4458-K	PTFE grease (Magna Lube) .75 oz. tube
44-285	14 oz. grease cartridge – fits standard grease guns
863009	Wet-Sol upper pump packing lubricant 1 quart
42-175	Pump packing lubricant 1 quart
863020	Air line lubricant 1 quart
207-11155-1	Air motor lubricant 2 oz
207-11155-2	Air motor lubricant 16 oz
0114-009433	Pump packing lube for solvent based materials, MX series pumps
0114-014871	Pump packing lube for water based materials, MX series pumps
SSL-10-K12	Devilbiss gun lube 12 ea 2 oz bottles
6-429	Binks Gunners Mate gun lube 20 ea 2 oz bottles

# Spray Gun Accessories & Misc. Products

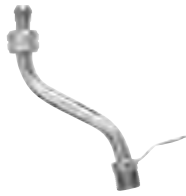

JGA-444, 54-957



PLH-MF-6-100



VS-531



54-990, 54-981



54-2831



GC-100-K4, GC-100-K48

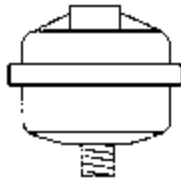

HAF-507-K12



AGA-414



AGA-415



54-380

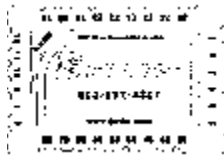

237-707

## Spray Gun Accessories

Part Number	Description
JGA-444	Fluid tube (JGA spray guns)
VS-532	Fluid Tube w/ inlet strainer (JGA spray guns)
54-957	Fluid inlet tube (95, 95SL, Mach 1, Mach 1SL, 2001)
PLH-MF-6-100	S.S. fluid strainer assembly, 100 mesh, 3/8" nps(m) x 3/8" nps(f)
VS-531	Fluid inlet strainer, 100 mesh
54-990	Fluid inlet strainer, 100 mesh
54-981	Fluid inlet strainer, 150 mesh
54-2831	Striping spray shield (replaces 54-372 ring)
GC-100-K4	Gun covers for manual spray guns (4/pkg.)
GC-100-K48	Gun covers for manual spray guns (48/pkg.)
HAF-507-K12	Whirlwind air filter gun mount (12/pkg.)
AGA-414	Gun mounting stud/rod (automatic spray guns)
AGA-415	Universal clamp (automatic spray guns)
54-380	Gun bracket (automatic spray guns)
237-707	Mil gauge

# Spray Gun Accessories & Misc. Products

**HAV-500**

**HAV-501**

**P-H-5516**

**HARG-510**

**85-441**

## Spray Gun Accessories

Part Number	Type	Inlet Size	Outlet Size	W or W/O Gauge Assy.	Max. Working Pressure	Recommended Range	Service Form
<b>873409</b>	Straight	1/4"npt(f)	1/4"npt(f)	W/O	100 psi	0-100 psi	n/a
<b>HAV-500</b>	Straight	1/4"nps(m)	1/4"nps(f)	W/O	125 psi	0-125 psi	SB-11-119
<b>HAV-501</b>	Straight	1/4"nps(m)	1/4"nps(f)	W / GA-338 Gauge	125 psi	0-125 psi	SB-11-119
<b>73-159</b>	90 Degree	1/4"nps(m)	1/4"nps(f)	W/O	250 psi	0-125 psi	n/a
<b>P-H-5516</b>	45 Degree	1/4"nps(m)	1/4"nps(f)	W/O	250 psi	0-125 psi	SB-11-119
<b>HARG-510</b>	Regulator	1/4"nps(m)	1/4"nps(f)	W / Gauge	300 psi	0-160 psi	SB-6-105
<b>85-441</b>	Regulator	1/4"nps(f)	1/4"nps(m)	W / Gauge	300 psi	0-50 psi	77-2825

# Spray Gun Accessories & Misc. Products



192219

## Spray Gun Stands (Gravity Feed Guns)

Part Number	Description	Notes
192219	Gun holder	Wall mount



6580-0000-1



49-1834



MSVAD-416, SSP-5034

## Misc. Products

Part Number	Description
6580-0000-1	Model 190 dusting gun with 60-40 nozzle
49-1834	Adapter fitting 3/4\"/>
MSVAD-416	Polyethylene hose sleeve, 100 ft
54-1439	Tip seal – use with 49-1839 adapter
41-661	5 gallon steel pail
SSP-5034	Polyethylene hose sleeve per foot

**BINKS**<sup>®</sup>  
www.binks.com

**DEVILBISS**<sup>®</sup>  
www.devilbiss.com

*Sales and Service Through A Global Network of Industrial Distributors*

**North American Office**  
Binks  
195 Internationale Blvd.  
Glendale Heights, IL 60139 USA  
630-237-5000

**Toll Free Customer Support**  
800-992-4657 USA & Canada Only